

Eaton Fuller[®] Heavy-Duty Transmissions TRDR0800 EN-US

June 2014

RTLO 1X718B Series
RTLO XX918B Series
RTLO 1X718B-T2 Series
RTLO XX918B-T2 Series



Powering Business Worldwide

BACKED BY

Roadranger

SUPPORT

Warnings and Cautions



Read the entire driver instructions before operating this transmission.

Set the parking brakes before starting a vehicle, always be seated in the driver's seat, move the shift lever to neutral, and depress the master clutch.

If engine cranks in any gear other than neutral or without the master clutch depressed, service your vehicle neutral safety start circuit immediately.

Before working on a vehicle or when leaving the cab with the engine running, place the transmission in neutral, set the parking brakes, and block the wheels.

Do not release the parking brake or attempt to select a gear until the air pressure is at the correct level.

When parking the vehicle or leaving the cab, always place the shift lever in neutral and set the parking brakes.

If your vehicle is equipped with a remote throttle, before operation, the transmission must be in neutral.

TOWING: To avoid damage to the transmission during towing, disconnect the driveline.

Every effort has been made to ensure the accuracy of all information in this manual. However, Eaton makes no expressed or implied warranty or representation based on the enclosed information. Any errors or omissions may be reported to Technical Services, Eaton, Vehicle Group, P.O. Box 4013, Kalamazoo, MI 49003.

Copyright Eaton, 2014. All rights reserved.

Table of Contents

Introduction

Warnings and Cautions	i
Model Designation	1
Identification Tag	2

Driving Operation

General Information	3
Shift Pattern Diagram	4
Shift Controls	5
Transmission Features	6
Driving Tips	8
Double-Clutching Procedure	9
Initial Start Up	10
Upshift Procedure	11
Top 2 Basic Operation and Overview	15
Upshift Procedure	16
Top 2 Driving Tips	17
Top 2 System Problem	18

Overview

Lubrication Procedures	19
Preventive Maintenance	22

Glossary

Definitions for Top 2 Transmissions	24
---	----

Introduction

Model Designation

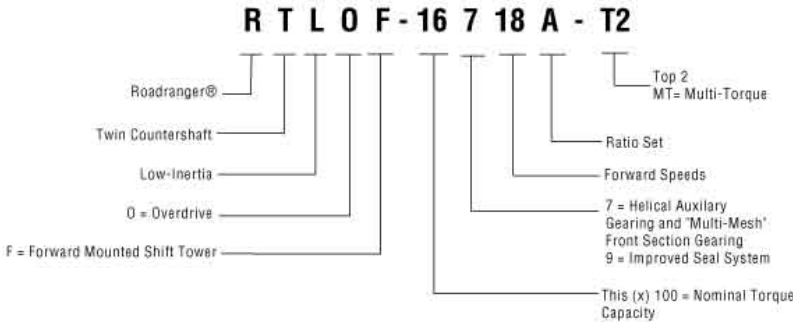

Overview

Identification Tag

Transmission Tag and Location

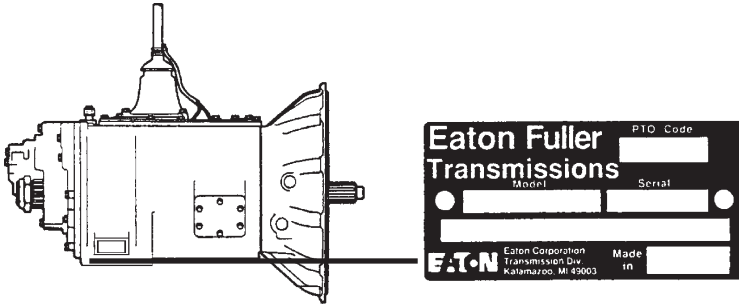

DO NOT REMOVE OR DESTROY THE TRANSMISSION IDENTIFICATION TAG.

Transmission model designation and other transmission identification information are stamped on the transmission tag. To identify the transmission model designation and serial number, locate the tag on the transmission and then locate the numbers as shown (example: RTLO-14610B).

Record transmission identification data. Have these reference numbers handy when ordering replacement parts or requesting service information.

General Information

This manual is designed to provide detailed information necessary for the proper driving techniques of the Eaton® Fuller® transmissions listed on the cover.

Introduction

Driver instructions are divided into two sections: Transmission Operation and Service and Maintenance. Transmission Operation contains information on driving techniques along with shift patterns. Service and Maintenance contains information items that deal with basic service and maintenance; such as, identification tags and lubrication information.

18-Speed Models

Models in this series provide eighteen forward speeds and four reverse, consisting of a five-speed front section and a 4-speed auxiliary section. The auxiliary section contains LO and HI range ratios, plus a splitter gear.

The LO position in the front section is used only as a starting gear, it is never used when the transmission is in HI range.

The other four ratios are used once in LO range and once again in HI range. However, each of the five ratios (LO-1-2-3-4) in LO range and each of the four ratios (5-6-7-8) in HI range can be split with the splitter gear.

After shifting out of the LO position, you use the easy Roadranger repeat "H" shift pattern. LO range and HI range are selected with the range lever. It is used once during the upshift sequence and once during the downshift sequence.

Always preselect the range shift. After preselection, the transmission automatically makes the synchronizer range shift as the shift lever passes through neutral.

Driving Operation

Shift Pattern Diagram

RTLO 1X718B Series
RTLO XX918B Series
RTLO 1X718B-T2 Series
RTLO XX918B-T2 Series

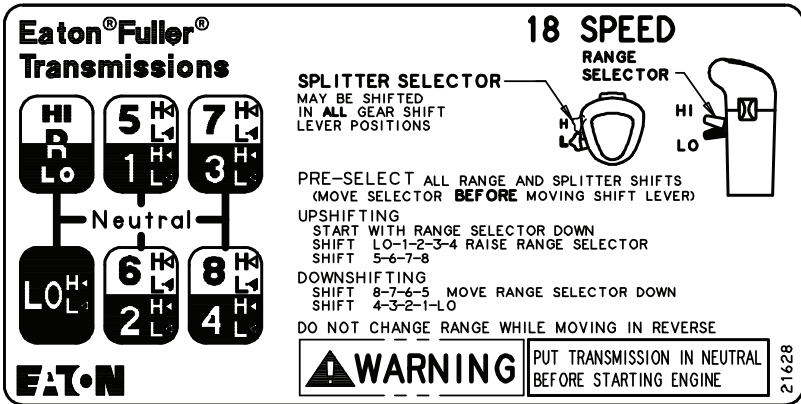

Shift Controls

Roadranger Valve

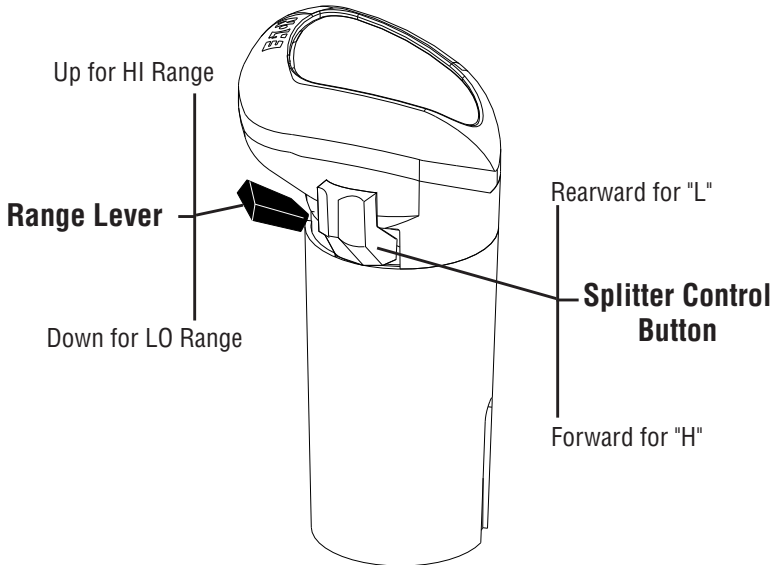

Driving Operation

Transmission Features

Range Shift

The range lever selects LO or HI range. It is used once during an upshift sequence and once during a downshift sequence.

Preselect

IMPORTANT: Always preselect all range shifts when upshifting or downshifting. Preselection requires that the range lever is moved to the needed position before starting the shift.

Preselected range shifts are completed automatically as the lever is moved through neutral and into the next gear. Preselecting all range shifts prevents damage to the transmission and provides for smoother shifts.

Splitter Shift

When in LO or HI range the ratios can be split by using the splitter control button. The LO range "L"/rearward position provides for LO through 4th speeds; the LO range "H"/forward position splits each of those speeds (providing 10 ratios in LO range). The HI range "L"/rearward position provides for 5th through 8th speeds; the HI range "H"/forward position splits each of those speeds (providing 8 ratios in HI range) - 18 progressive ratios can be obtained.

Optional Equipment

For easier and faster engagement while the vehicle is standing still, some Eaton® Fuller® transmissions may be equipped with either a Countershaft Brake or a Clutch Brake.

Countershaft Brake

(Used with push-type clutches) - The control button is mounted on the shift lever just below the shift knob. To operate, disengage the clutch, press down the control button, and shift into LO or reverse. This is an air operated mechanical brake which slows down the transmission gearing by forcing a piston against the countershaft PTO gear. Never use the Countershaft Brake when upshifting or downshifting. Use **only** for initial gear engagement when the vehicle is standing still.

Clutch Brake

(Used with pull-type clutches) - The clutch brake is applied by fully depressing the clutch pedal to the floor board. When applied the brake slows down and can stop the transmission front box gearing. It is a disc-type brake incorporated into the clutch and transmission drive gear assemblies. Never use the Clutch Brake when upshifting or downshifting. Use **only** for initial gear engagement when the vehicle is standing still.

Driving Operation

Driving Tips

- Always select an initial starting gear that provides sufficient reduction for the load and terrain.
- Always use normal double-clutching procedures when making lever shifts.
- Never slam or jerk the shift lever to complete gear engagements.
- Never coast with the shift lever in the neutral position.
- Never move the range lever with the shift lever in neutral while the vehicle is moving.
- Never make a range shift while moving in reverse.
- Never downshift at too high of a road speed.
- In most cases, depending on the engine and axle ratios, you can save valuable fuel by operating the vehicle at less than governed RPM while cruising in top gear.
- Never move the shift lever to the LO speed gear position while operating in HI range.
- Never make a splitter shift while moving in reverse.
- Do not lug engine below peak torque (1200 r.p.m.).

Double-Clutching Procedure

Special Instructions

Purpose:

- a. To break torque to allow the transmission to come out of gear, and...
- b. To disengage the engine from the transmission when shifting into gear.

Procedure

1. Release accelerator.
2. Depress clutch pedal slightly to break torque enough to move the shift lever to neutral.

Note: Avoid depressing the clutch pedal too far and contacting the clutch brake.

3. When the shift lever is in neutral, let up on clutch pedal.

Note: Engaging the clutch with the shift lever in the neutral position connects the transmission input gearing to the engine. This allows the operator to speed up or slow down the transmission input gearing to properly match the desired gear speed to the current road speed.

- a. For upshifts - allow engine RPM to decrease to match road speed.
- b. For downshifts - increase engine RPM to match road speed.
4. At the correct engine RPM, depress the clutch pedal slightly and **at the same time**, move the shift lever into the desired gear.
5. Let up on the clutch pedal and apply accelerator.

Driving Operation

Initial Start Up

Special Instructions



WARNING: Before starting a vehicle always be seated in the driver's seat, move the shift lever to neutral, and set the parking brakes.



CAUTION: Before moving a vehicle, make sure you understand your shift pattern configuration. A shift label should be in your vehicle's cab. If not, refer to General Information to order one.

1. Make sure the shift lever is in neutral and the parking brakes are set.
2. Turn on the key switch, start the engine.
3. Allow the vehicle air pressure to build to the correct level. Refer to your "Operator and Service Manual" supplied with the truck.
4. Apply the service brakes.
5. Make sure the range lever is down in the LO range position and the splitter control button is rearward.



Range Lever MUST be in the LO Range position for LO Range.



And Splitter Control Button Rearward

6. Depress the clutch pedal to the floor.
7. Move the shift lever to desired initial gear.
8. Release the parking brakes on the vehicle.
9. Slowly release the clutch pedal and apply accelerator.

Upshift Procedure

In the following instructions, it is assumed that the driver is familiar with operating heavy-duty trucks and tractors, and can coordinate the movement of the shift lever and clutch pedal to make smooth gear engagements while upshifting or downshifting. Always double-clutch when making lever shifts.



CAUTION: Never move the range lever or the splitter control button with the shift lever in neutral while the vehicle is moving.

Splitter shift - LO Range "L" to LO Range "H" (LO "L" to LO "H")

1. Pre-select just before making an upshift by moving the button forward while maintaining accelerator position.
2. Then, **immediately**, release the accelerator, depress the clutch pedal once to break torque, release the pedal to reengage the clutch, allow the engine to decelerate until the shift is complete. Continue driving or upshifting. The transmission shifts from "L" to "H" when synchronous is reached.

Combination Lever shift and Splitter shift - LO Range "H" to LO Range "L" (LO "H" to 1st "L")

3. Pre-select just before making an upshift by moving the button rearward while maintaining accelerator position.
4. Move the shift lever, double-clutching, to the 1st speed gear position. If the splitter control button is not moved, the transmission will be in 1st H once the final clutch engagement is made.



CAUTION: Never move the splitter control button or the range lever with the shift lever in neutral while the vehicle is moving.

5. Continue upshifting through the shift pattern. Double-clutching during lever shifts, single-clutch during split shifts while the shift lever is in the same position.

Driving Operation

Combination Lever shift and Splitter shift - LO Range "H" to HI Range "L" (4th H to 5th L)... (Range shift)

6. Pre-select just before making an upshift by moving the button rearward while maintaining accelerator position.
7. Pull up the Range Lever, move the shift lever, double-clutching, to the 5th speed gear position. If the splitter control button is not moved, the transmission will be in 5th H once the final clutch engagement is made.



CAUTION: Never move the splitter button or the range lever with the shift lever in neutral while the vehicle is moving.

8. Continue upshifting through the shift pattern. Double-clutching during lever shifts, single-clutch during split shifts while the shift lever is in the same position.

Splitter shift - HI Range "L" to HI Range "H" (5th L to 5th H)

9. Pre-select just before making an upshift by moving the button forward while maintaining accelerator position.
10. Then, **immediately**, release the accelerator, depress the clutch pedal once to break torque, release the pedal to reengage the clutch, allow the engine to decelerate until the shift is complete. Continue driving or upshifting. The transmission shifts from "L" to "H" when synchronous is reached.

Combination Lever shift and Splitter shift - HI Range "H" to HI Range "L" (5th H to 6th L)

11. Move the splitter control button into the rearward position.
12. Move the shift lever, double-clutching, to the 6th speed gear position. If the splitter control button is not moved, the transmission will be in 6th H once the final clutch engagement is made.



CAUTION: Never move the splitter button or the range lever with the shift lever in neutral while the vehicle is moving.

13. Continue upshifting through the shift pattern. Double-clutching during lever shifts, single-clutch during split shifts while the shift lever is in the same position.

Downshift Procedure

In the following instructions, it is assumed that the driver is familiar with operating heavy-duty trucks and tractors, and can coordinate the movement of the shift lever and clutch pedal to make smooth gear engagements while upshifting or downshifting. Always double-clutch when making lever shifts.



CAUTION: Never move the range lever or the splitter control button with the shift lever in neutral while the vehicle is moving.

Splitter shift - HI Range "H" to HI Range "L" (8th H to 8th L)

14. Pre-select just before making a downshift by moving the button rearward while maintaining accelerator position.
15. Then, **immediately**, release the accelerator, depress the clutch pedal once to break torque, release the pedal to reengage the clutch, accelerate the engine until the shift is complete. Continue driving or downshifting. The transmission shifts from "H" to "L" when synchronous is reached.

Combination Lever shift and Splitter shift - HI Range "L" to HI Range "H" (7th L to 6th H)

16. Pre-select just before making a downshift by moving the button forward while maintaining accelerator position.
17. Then, **immediately** move the shift lever, double-clutching, to the next lower gear position. If the splitter control button is not moved, the transmission will be in 6th "L" once the final clutch engagement is made.
18. Continue downshifting through HI range. Double-clutching during lever shifts, single-clutch during split shifts while the shift lever is in the same position.

Driving Operation

Combination Lever shift and Splitter shift - HI Range "L" to LO Range "H" (5th L to 4th H)... (Range Shift)

19. Pre-select just before making a downshift by moving the button forward while maintaining accelerator position.
20. Push the range lever down, **immediately** move the shift lever, double-clutching, to the next lower gear position. If the splitter control button is not moved, the transmission will be in 4th "L" once the final clutch engagement is made.
21. Continue downshifting through LO range. Double-clutching during lever shifts, single-clutch during split shifts while the shift lever is in the same position.

Splitter shift - LO Range "H" to LO Range "L" (4th H to 4th L)

22. Pre-select just before making a downshift by moving the button rearward while maintaining accelerator position.
23. Then, **immediately**, release the accelerator, depress the clutch pedal once to break torque, release the pedal to reengage the clutch, accelerate the engine until the shift is complete. Continue driving or downshifting. The transmission shifts from "H" to "L" when synchronous is reached.

Combination Lever shift and Splitter shift - LO Range "L" to LO Range "H" (4th L to 3rd H)

24. Pre-select just before making a downshift by moving the button forward while maintaining accelerator position.
25. Then, **immediately** move the shift lever, double-clutching, to the next lower gear position. If the splitter control button is not moved, the transmission will be in 3rd "L" once the final clutch engagement is made.
26. Continue downshifting through LO range. Double-clutching during lever shifts, single-clutch during split shifts while the shift lever is in the same position.

Driving Operation

Top 2 Basic Operation and Overview

The Super 18 Top 2 transmission operates like a normal Super 18 in positions LO through 7th H. The transmission shifts automatically in the "AUTO" position based on engine speed and load.

When the transmission is in the Top 2 Mode, the system will:

- Shift the transmission between top 2 gears automatically.
- Increase or decrease engine speed during a Top 2 shift.
- Momentarily interrupt cruise control or engine brake during the shift.

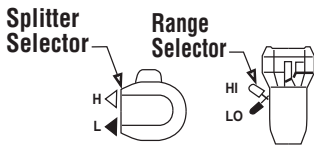
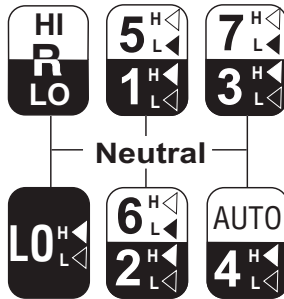

LO Range
Shift LO L, 1st L, 2nd L, 3rd L, 4th L

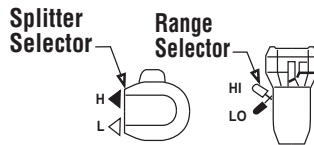

LO Range
Shift LO H, 1st H, 2nd H, 3rd H, 4th H

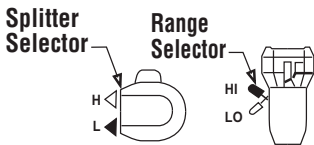

HI Range
Shift 5th L, 6th L, 7th L

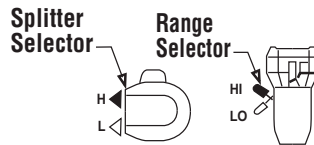

HI Range
Shift 5th H, 6th H, 7th H

Driving Operation

Upshift Procedure

1. Upshift the transmission through the shift pattern to 7th H position. Double-clutching during lever shifts and breaking torque during button shifts.
2. When the engine has reached the shift point use the normal double-clutching procedure and move the shift lever into "AUTO" position.

Note: The position of the splitter selector does not matter when moving the lever into the "AUTO" position. It is recommended to leave the splitter selector in the forward position so it is ready when you want to make a downshift into 7th H position.

3. When the engine has reached the shift point the transmission will automatically shift into top gear.

Downshift Procedure

4. To downshift from top gear: Once the engine has reached the shift point the transmission will automatically downshift.
5. To downshift from "AUTO" position to 7th H:
 - a. While in "AUTO" position, make sure the splitter selector is in the forward position.
 - b. Once the engine has reached the shift point move the lever to the next lower lever position while double-clutching.
6. Continue downshifting through the shift pattern, double-clutching during lever shifts and breaking torque during button shifts.

Top 2 Driving Tips

To activate Top 2 mode, the transmission must be shifted from 7th H to "AUTO" once the engine has reached the normal shift point. If the operator moves the shift lever into the AUTO lever position below the engines' normal shift point, the transmission will be in normal mode. Once the engine reaches the normal shift point, Top 2 mode will become active.

Throttle position determines the upshift point. Less throttle will lower the shift point. Zero throttle (down hill push) will raise the up shift point. To reset the shift points the engine must drop below it's normal shift point.

When the engine brake active, the up and down shift points will be raised.

A feature of Top 2 is ANTI HUNT mode. This is built in to avoid constant upshifts and downshifts. When the shift lever is in the AUTO position and the transmission has just completed an upshift, the downshift point will be lower than normal. If the transmission has just completed a downshift, the upshift point will now be higher than normal.

Driving Operation

Top 2 System Problem

If the system malfunctions, the transmission will typically default to Super 18 mode. For some malfunctions, the system will detect a failure, that the operator must allow the Top 2 to “time out” - this will take 9 seconds. During the 9 seconds the Top 2 will try to complete the shift. Once the Top 2 has timed out the operator must place the transmission in neutral to obtain manual Super 18 mode. The Top 2 function will be inactive until the vehicle is stopped and the key is turned off.

In some situations, the system can be reset at a stop by leaving the key off for 10 seconds and then restarting the engine. If this does not clear the problem verify air pressure and check the electrical connections to the Top 2. To help assure operation of the Super 18 Top 2, advise your maintenance personnel of any oil leaks, above normal operating temperatures, unusual noises, fault codes, or if the transmission is not operating correctly.

These instructions assume the driver is currently familiar with the operation of a normal Super 18 transmission.

Lubrication Procedures

Proper lubrication procedures are the key to a good all-around maintenance program.

Eaton® Fuller® Transmissions are designed so that the internal parts operate in an oil circulating bath created by the motion of the gears and shafts.

All parts will be properly lubricated if these procedures are closely followed:

- a. Maintain oil level. Inspect regularly.
- b. Follow maintenance interval chart.
- c. Use the correct grade and type of oil.
- d. Buy from a reputable dealer.

Maintain Proper Oil Level

Make sure oil is level with the filler opening. Being able to reach oil with your finger does not mean oil is at proper level. (One inch of oil level is about one gallon of oil.)

When adding oil, never mix engine oils and gear oils in the same transmission.

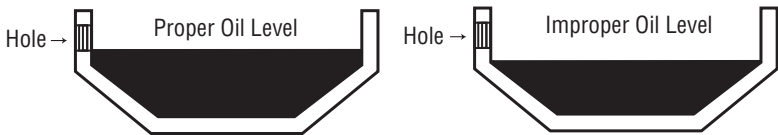

For additional lubrication information, see TCMT-0021.

If your vehicle has a transmission oil filter, you must change the filter when fluid or lubricant is changed.

Additives and friction modifiers must not be introduced.

Never mix engine oils & gear oils in the same transmission.

The use of lubricants not meeting these requirements will affect warranty coverage.

For a list of Eaton Approved Synthetic Lubricants see TCMT-0020 or call 1-800-826-HELP (4357).

Overview

Operating Temperatures with Oil Coolers

Operating at temperatures above 250° F (120°C) causes loaded gear tooth temperatures to exceed 350°F (177°C) which will ultimately destroy the heat treatment of the gears. Temperatures above 250°F (120°C) should be regarded as a warning of inadequate cooling. If the elevated temperature is associated with unusual operating conditions that will reoccur, a cooler should be added, or the capacity of the existing cooling system increased.

The following conditions in any combination can cause operating temperatures of over 250°F:

- Operating consistently at slow speed.
- High ambient temperatures.
- Restricted air flow around transmission.
- Exhaust system too close to transmission.
- High horsepower operation.

External oil coolers are available to reduce operating temperatures when the above conditions are encountered.

Oil Cooler Chart

Transmission Oil Coolers are:
Recommended
• With engines of 350 H.P. and above.
Required
• With engines 399 H.P. and above and GCW's over 90,000 lbs.
• With engines 399 H.P. and above and 1400 lbs. ft. or greater torque.
• With engines 450 H.P. and above.

Preventive Maintenance

Grease Fitting On
Each Side To
Lubricate Clutch
Pedal Shaft

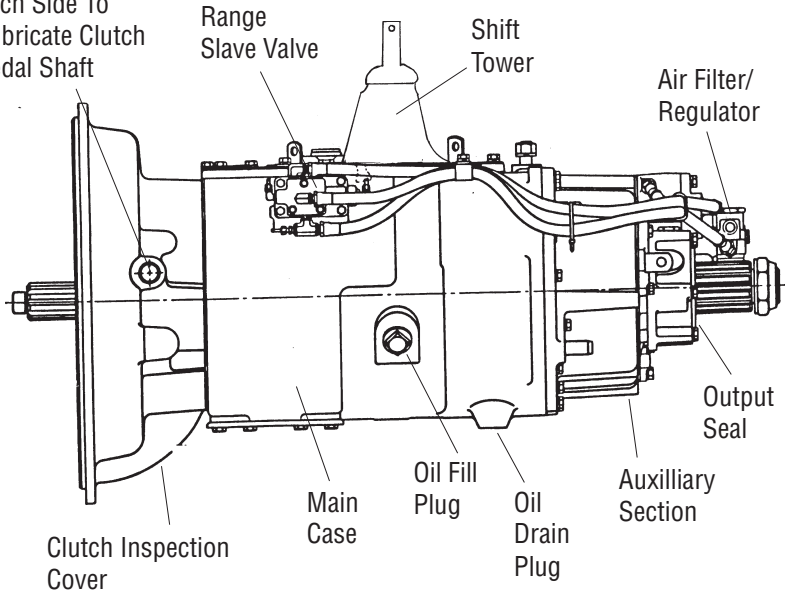

The following maintenance items are necessary to prevent costly transmission failures which may not be covered by warranty.

Transmission Oil

- Check transmission daily for oil leaks. Repair promptly to prevent oil loss and subsequent transmission failure.
- Check transmission oil level at every engine oil change interval. Add transmission oil as necessary.
- Drain and replace transmission oil as recommended by the schedule in this book.

Overview

Air System

- Drain moisture from vehicle air system daily.
- Listen for air leaks daily, repair promptly.
- If the vehicle is equipped with an air dryer, confirm that the air dryer system is working properly. Repair as necessary.
- Service the vehicle air compressor as required to prevent oil from entering the vehicle air system.

Master Clutch System

- Lubricate clutch release pedal shaft bushings at every chassis lubrication interval. There should be one grease fitting on each side of the transmission clutch housing.
- Have the clutch checked and adjusted if any of the following occurs:
 - Clutch does not disengage completely
 - Clutch brake does not function
 - Clutch pedal free-play is less than 1/2".
- When replacing the clutch, use a high quality, spring-damped replacement unit.

Drivetrain

- Inspect the driveshaft for loose or worn U-joints weekly. Repair promptly to prevent excessive driveline vibration.
- Have the driveline checked by a repair facility if unusual noise or vibration is detected.

Overall Inspection

- Inspect the transmission at the chassis lubrication interval for loose or missing capscrews and fasteners. Pay particular attention to the capscrews that attach the transmission to the engine.

Definitions for Top 2 Transmissions

Auto Position	When the shift lever is in the position labeled "AUTO". This position is where the Top 2 gears are located.
Break Torque	Releasing engine power or load from transmission and drivetrain.
Double-Clutch	The shifting technique used when moving the shift lever to the next lever position. Procedures: Depress clutch, move lever to neutral, let up clutch, accelerate or decelerate engine to obtain synchronous, depress clutch pedal again, and move lever into gear.
Splitter Selector	The button on the side of the shift knob used to change gears.
Synchronous	The point at which the input gearing speed (engine) matches output gearing speed (road speed) and a shift can occur without grinding.
Top 2 Mode	The state where the transmission automatically shifts between the top two gears.

Copyright Eaton, 2014.

Eaton hereby grant their customers, vendors, or distributors permission to freely copy, reproduce and/or distribute this document in printed format. It may be copied only in its entirety without any changes or modifications. THIS INFORMATION IS NOT INTENDED FOR SALE OR RESALE, AND THIS NOTICE MUST REMAIN ON ALL COPIES.

Note: Features and specifications listed in this document are subject to change without notice and represent the maximum capabilities of the software and products with all options installed. Although every attempt has been made to ensure the accuracy of information contained within, Eaton makes no representation about the completeness, correctness or accuracy and assumes no responsibility for any errors or omissions. Features and functionality may vary depending on selected options.

For spec'ing or service assistance, call 1-800-826-HELP (4357) or visit www.eaton.com/roadranger. In Mexico, call 001-800-826-4357.

Roadranger: Eaton and trusted partners providing the best products and services in the industry, ensuring more time on the road.

Eaton

Vehicle Group
P.O. Box 4013
Kalamazoo, MI 49003 USA
800-826-HELP (4357)
www.eaton.com/roadranger

Printed in USA



BACKED BY
Roadranger
SUPPORT