



Automatic Positive Locking Traction Differential

OWNER'S MANUAL

With warnings and precautions on back cover

Tractech has been a leading manufacturer of premium quality traction-adding differentials for over 50 years. Each step in our manufacturing process, from design to final assembly and inspection reflects the highest industry standards

This manual is intended to help provide safe and trouble free operation of NoSPIN/Detroit Locker differentials for the life of the product. We strongly recommend that all who come in contact with the products read this manual thoroughly.

GENERAL INFORMATION AND RECOMMENDATIONS

To Contact Tractech Inc.

Telephone:

(586) 759-3850 U.S.A.

FAX:

(586) 759-1645 U.S.A.

Web Site:

www.tractech.com

Office Hours:

7:30 - 4:30 (FT) Mon. - Fri.

General Assistance:

Customer Service Dept.

Technical Assistance:

Engineering Dept.

Warranty Assistance:

Customer Service Dept.

Printed Matter:

Marketing Department

Glossary

To assist the reader in understanding the language in this manual a Glossary is included.

Limited Warranty

The complete Tractech Limited Warranty appears on page 22 Owners of NoSPIN/Detroit Locker differentials are encouraged to read this warranty carefully before putting the vehicle into service.

Technical Bulletins

Tractech has published several Technical Bulletins which are helpful supplements to the information presented throughout this manual Copies are available by writing to the Marketing Dept.

Application Approval

It is essential that NoSPIN/Detroit Locker differentials be used only in applications approved by Tractech Engineering. Read page 3 carefully and follow the stated guidelines.

Model Lists

Refer only to approved Tractech model lists when ordering or specifying the products. Copies are available by writing to the Marketing Dept - Web page www.tractech.com.

Vehicle Performance

The performance of a vehicle equipped with a NoSPIN/Detroit Locker differential is somewhat different from that of a vehicle equipped with a conventional differential. Read page 4 carefully to assure proper understanding of the characteristics of the product.

Installation

Before installing NoSPIN/Detroit Locker differentials, read pages 7-11 Note: Tractech recommends that a competent driveline mechanic perform the installation in that tools of the trade are required. Note: The vehicle/axle manufacturer's instructions for installing a conventional differential must be consulted when disassembling and reassembling axle components and when making all final adjustments.

Maintenance

Refer to pages 13-16 for important information regarding proper maintenance of your NoSPIN/Detroit Locker differential. Carefully follow the recommended lubrication, service and inspection procedures.

Trouble Shooting

Information on pages 17-18 will help owners and operators of NoSPIN equipped vehicles diagnose and correct problems related to vehicle performance.

TABLE OF CONTENTS

PREFACE, GENERAL INFORMATION AND RECOMMENDATIONS	1
APPLICATION	3
VEHICLE PERFORMANCE	4
EXPLODED VIEWS OF REPRESENTATIVE ASSEMBLIES	5
OPERATION	6
INSTALLATION	7-11
TESTS FOR PROPER INSTALLATION AND OPERATION	12
MAINTENANCE	13-16
TROUBLE SHOOTING	17-18
NEW IMPROVED DETROIT LOCKER™ SPECIAL INSTRUCTIONS	19
NEW DETROIT C-LOCKER FOR C-CLIP AXLES - SPECIAL INSTRUCTIONS	20
GLOSSARY	21
LIMITED WARRANTY AND EXCLUSIONS	22
WARNING, PRECAUTIONS	23
INSTRUCTIONS TO AXLE MANUFACTURER AND CHASSIS ASSEMBLY PLANT	24

APPLICATION APPROVAL

Over the past 50 years, the NoSPIN differential has been successfully utilized by a variety of on/off road vehicle/axle manufacturers. Traditional applications are Medium/Heavy Truck, Construction, Mining, Forestry, Agricultural, Military and Specialty Vehicles.

O ensure successful application of our product, Tractech Engineering requires approval for each new vehicle/axle application. The following guidelines are examples of successful NoSPIN differential application:

Applications:

- **6x4 (tandem-drive axle)** Trucks Primary location - forward rear. Both rear axles for maximum mobility if used 75% off-road.
- **4x4 Off-Road Vehicles** Farm tractors (articulated & rigid) front axle. Also rear axle for maximum traction.
(Consult Tractech Engineering.)
- **Farm Tractors** (straight frame with front-wheel-drive) -front axle only
(cannot be used in rear axle with individual wheel brakes).
- **Loader** - One axle only, either front or rear.
- **Trencher** - One or both axles.
- **Front drive axles** of Light Trucks. While successful in specialty vehicles, this application must be reviewed and approved by Tractech Engineering.

It is important when considering the use of a traction device to review key vehicle parameters i.e., loading, geometry, power requirements, duty cycles (miles/hours) etc.

The following marginal applications must be reviewed with Tractech Engineering Application Approval Form No. 7003 is required. Successful field testing must be performed by the customer prior to production approval by Tractech.

Examples are:

Transit Buses- NoSPIN should not be used when operated in cities where sharp turns are required continually changing lanes, as in leaving bus stops to avoid parked vehicles.

Transit buses utilized in non city operations are an acceptable application. School busses have also proven to be another successful application for NoSPIN.

- **Yard Tractors** (Spotters)
- **Light-duty Pickup Trucks** - Equipped with fifth wheels to pull "gooseneck" trailers in pickup and delivery operations unless equipped with automatic transmission.
- **Small Fork Lift Trucks** -with short wheelbase and high turn angle capability utilized inside buildings on smooth surfaces.
- Highway Tractors - with less than 120" wheelbase (see page 4 for details).

CAUTION:

ANY INCREASE IN THE SIZE OF THE VEHICLE'S ENGINE, TIRES, WEIGHT, ETC., MAY PROHIBIT USE OF A NoSPIN DIFFERENTIAL IN A HERETOFORE APPROVED APPLICATION. ANY SUCH MODIFICATION SHOULD BE REVIEWED BY TRACTECH ENGINEERING BEFORE CONTINUING TO USE THE PRODUCT.

THE NoSPIN DIFFERENTIAL DOES NOT INCREASE THE LOAD-CARRYING CAPACITY OR PAYLOAD RATING OF THE VEHICLE OR VEHICLE COMBINATION.

• **Model Lists**

Refer only to approved Tractech model lists when ordering or specifying NoSPIN/Detroit Locker differentials.
Copies are available by writing to the Marketing Dept.

*1995 Tractech inc.

*NoSpin, Detroit Locker, Improved Detroit Locker and Detroit C-Locker are registered Trademarks of Tractech Inc.

VEHICLE PERFORMANCE

The performance of a vehicle equipped with a NoSPIN/Detroit Locker differential is somewhat different from that of a vehicle equipped with a conventional differential. For example:

When turning a corner, the sound of component disengagement and re-engagement may be audible, and the transfer of driving torque from both wheels to one wheel may be noticeable.

When going from drive (acceleration) to coast (deceleration) in a turn, a "metallic" sound may be heard as torque flow is reversed (inside wheel engaged during acceleration; outside wheel engaged during deceleration).

These characteristics are normal because of backlash designed into the NoSPIN differential, which is of a fixed amount (1 to 2 inches of rotation at the tire tread).

Backlash or slack between the driving and driven clutch teeth is an inherent part of the NoSPIN and necessary to permit automatic operation when driving in forward and reverse. The total backlash in the driveline is increased by the amount of the reduction between the ring gear and pinion. If the ring gear-pinion ratio is 5 to 1, the total backlash in the driveline with the NoSPIN would be about 30° . This in turn is increased by clearances between planetary gear, sliding splines and the ring and pinion gear. We feel that the total driveline slack can amount to as much as 1/4th turn of the driveline without being abnormal, but if it exceeds 1/4 turn, other parts in the drivetrain could be checked. Further clarification of operational and performance characteristics is available through Technical Bulletin No. 81 -1044. A copy is available by writing to our Marketing Dept.

Anything that improperly causes a difference in individual wheel speeds, such as mismatched tire diameters due to differences in tire wear or tire pressure, or unbalanced loading of the vehicle (especially cargo vehicles, or vehicles operated on a side slope) can cause the NoSPIN differential to deliver power to only one side of the vehicle and thus cause steering problems.

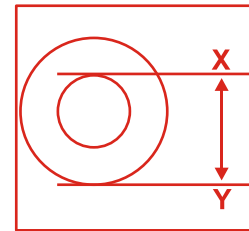

The diameter of the tires can be adjusted by varying the air pressure of the tires.
Match the distance from the top of each tire rim to the pavement.

When negotiating a turn (outside wheel disengaged), the inside wheel under conditions of poor traction may receive excessive torque, which could cause it to break traction momentarily until its speed is equal to the outside wheel. This will result in re-engagement of the outside wheel thus allowing both wheels to be driven. This condition is most noticeable with lightly loaded axles.

Certain vehicles equipped with NoSPIN differentials, such as short wheelbase trucks (e.g., under 120" wheelbase) and four wheel drive trucks with a NoSPIN differential in the front steering axle, can experience "understeer" when negotiating a turn under power. Releasing the accelerator will reduce the torque and improve steering.

Use extreme caution when accelerating or decelerating on slippery or unstable surfaces. Vehicles/axles equipped with traction differentials are inherently more sensitive to side-slip than vehicles equipped with conventional differentials. Stability can be retained if side-slip occurs by decelerating (Letting off the accelerator) CAUTION: DO NOT APPLY THE BRAKE. TO DO SO MAY RESULT IN LOSS OF VEHICLE CONTROL.

Braking capacity is reduced when a NoSPIN differential equipped vehicle makes a turn while coasting downhill in that the inside wheel is then disconnected from the driveline. Operating in low gear will allow the engine to act as a retarder and will improve braking capacity.

If the vehicle is stationary on a dry surface, easier steering can be achieved by moving the vehicle slightly in either forward or reverse. (Assure that proper steering pressure is maintained.)

NOTE:

If placing limited-slip differentials in Rockwell, Eaton or-Dana axles with NoSPIN differentials, also replace the differential case halves with the axle manufacturer's standard differential case halves NoSPIN differentials are designed to fit standard differential case halves. NoSPIN differentials will not fit properly into limited-slip differential case halves.

THE NoSPIN DIFFERENTIAL DOES NOT INCREASE THE LOAD-CARRYING CAPACITY OR PAYLOAD RATING OF THE VEHICLE OR VEHICLE COMBINATION.

IMPORTANT! READ THE CAUTIONARY NOTICES REFERENCED ON THE BACK COVER.

EXPLODED VIEWS OF REPRESENTATIVE ASSEMBLIES

The following exploded views of NoSPIN differentials (there are five "styles")* illustrate the various components that make up the complete assembly. Certain components differ slightly in appearance between style, but their function - and the function of each of the five style NoSPIN differentials - is the same

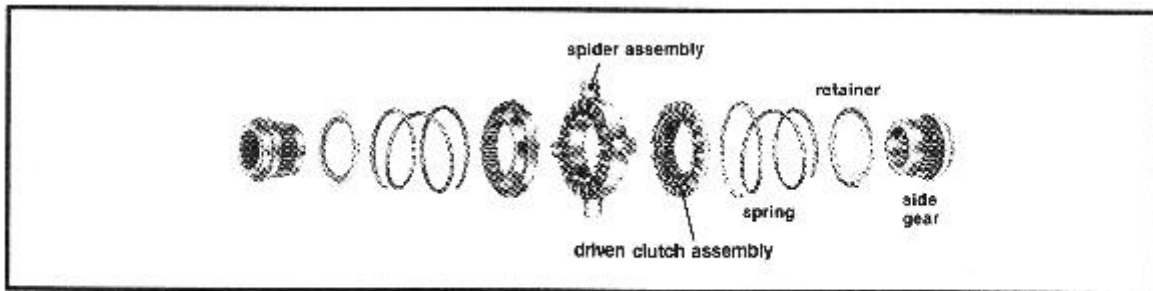

NoSPIN differential with spider assembly and external springs and retainers; fits support case in vehicle.

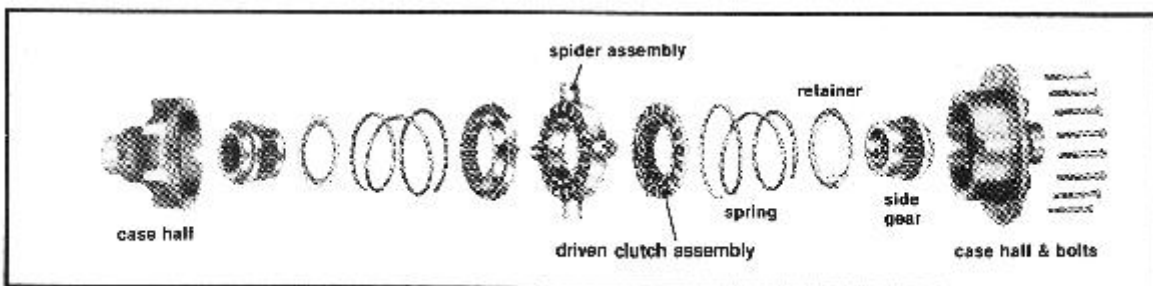

NoSPIN differential with spider assembly and external springs and retainers; supplied with support case.

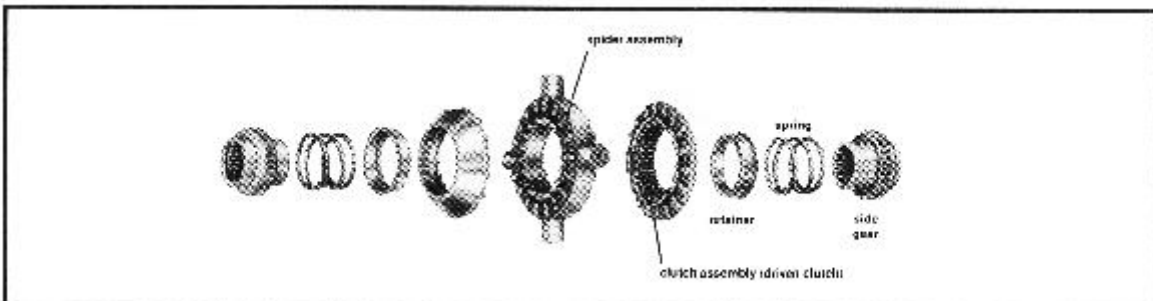

NoSPIN differential with spider assembly and internal springs and retainers; fits support case in vehicle.

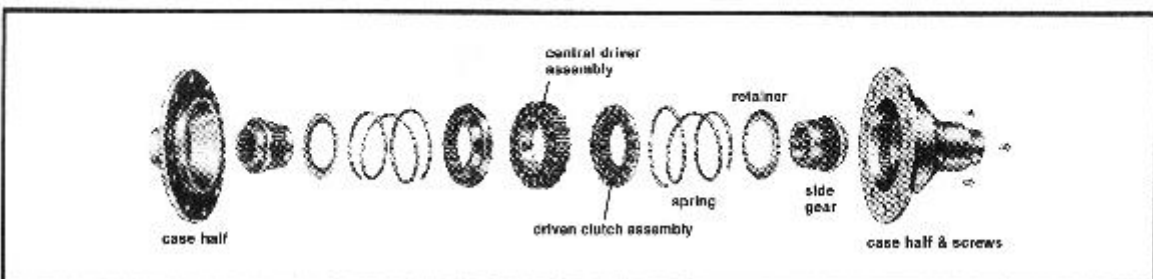

Assembly style not shown:

New IMPROVED Detroit Locker. See page 19

Models with central driver, external springs and retainers, without support case.

Copies of style not shown are available by writing to the Marketing Dept.

OPERATION

The NoSPIN differential powers both wheels. Yet freely permits wheel speed differentiation when required.

Prime functions

1. Assures 100% of the available torque and increases drawbar pull.
2. Prevents wheel spin and power loss when one wheel loses traction.
3. Compensates for differences in wheel travel when turning or operating on uneven surfaces.

The drive axle illustrated below (Fig. 1) is equipped with a NoSPIN differential. Note that there are no spider gears, but rather two drive members, called driven clutch assemblies. They mate with a spider assembly which is driven by the ring gear through the differential support case.

As long as the vehicle is operated in a straight forward or reverse direction over a smooth surface, the driven clutch assemblies remain locked to the spider assembly.

The NoSPIN differential allows the vehicle to perform as if the axle half-shafts had been welded - the axle is completely locked. This means both wheels turn at the same speed. If one wheel loses traction or leaves the ground, the opposite wheel, which still has traction, continues to drive the vehicle until traction is regained by both wheels. There can be no one wheel spinout. (Fig. 2)

When the vehicle turns a corner, or when one wheel passes over an obstruction, the outside wheel, or the wheel passing over the obstruction, must travel a greater distance and therefore faster than the other wheel. When this occurs, the NoSPIN differential automatically allows for the necessary difference in wheel speed.

During a turn (Fig. 1), the inside driven clutch remains completely engaged with the spider and continues to drive the vehicle. The outside driven clutch automatically disengages from the spider, allowing the outer wheel to turn freely in the turn. When the vehicle completes the turn, the outside driven clutch automatically reengages the spider, as both wheels again travel at the same speed.

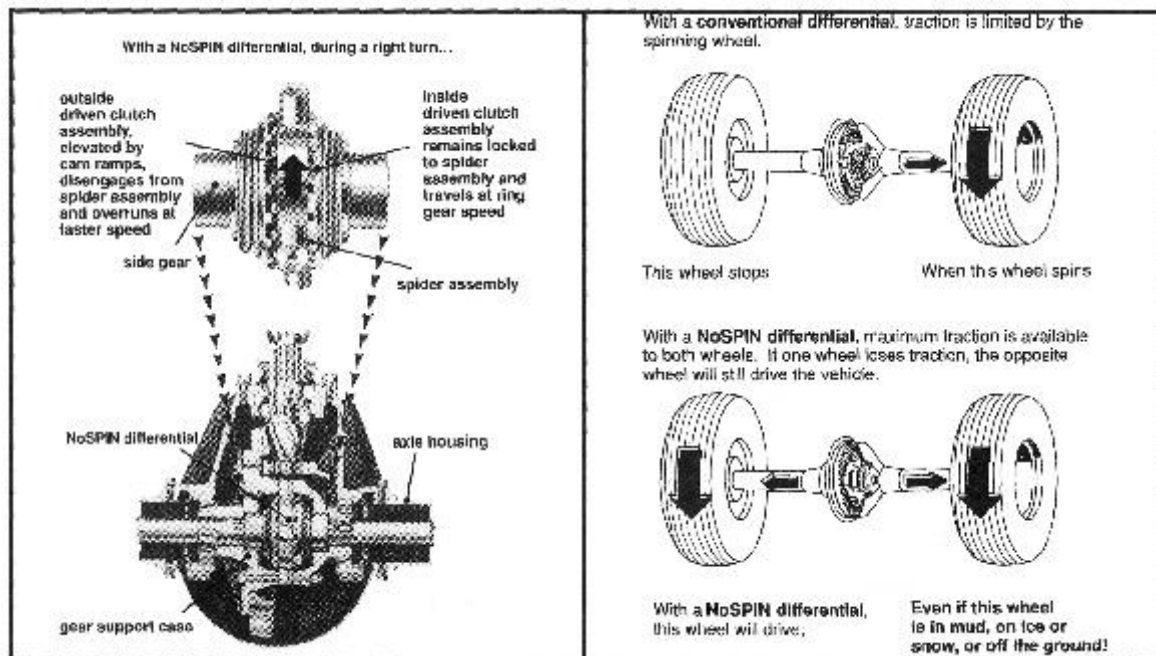

INSTALLATION

Refer only to an approved Tractech model list when ordering or specifying the product. Copies are available by writing to the Marketing Department.

It is essential that NoSPIN/Detroit Locker differentials be used only in applications approved by Tractech Engineering. Read pages 3-4 carefully and follow the approved guidelines.

The installation procedure presented on pages 7-11 applies to all NoSPIN differentials (except 'R' Model NoSPIN Differentials). However, the procedure will differ slightly depending upon the specific vehicle. Therefore it is essential to consult the vehicle/axle manufacturer's instructions for installing a differential.

Most NoSPIN/Detroit Locker differentials are designed to fit directly into the standard differential support case in the vehicle. Where it is not possible to fit the standard support case manufactured by the vehicle/axle maker, the NoSPIN differential is supplied with a case manufactured by Tractech. Therefore, two sets of installation instructions are provided.

NoSPIN differentials are easily installed in the field. However, it is recommended that a competent driveline mechanic do the work in that tools of the trade are required.

The NoSPIN differential is designed to fit the components in the axle. No machining is required. The procedure is the same as it is for installing the original differential. A competent mechanic can install the NoSPIN in the same time required to replace the original differential. Caution: It is recommended every safety precaution be practiced while performing the work when disassembling and reassembling axle components and when making all final adjustments.



Installation Instructions: NoSPIN/Detroit Locker Differentials Supplied Without a Support Case

INSTALLATION

Disassembly: (Steps 1-5)

Step 1

Refer to the vehicle/axle manufacturer's recommendations for removing the differential assembly from the axle. Ensure that all safety precautions are implemented.

Step 2

Following the procedure recommended by the vehicle or axle manufacturer, remove the ring gear and differential case assembly from the axle carrier.

CAUTION:

Do not use heat to disassemble drive axles. To do so can destroy heat treat properties, weaken or distort axle components or result in a mishap which can cause injury, even death.

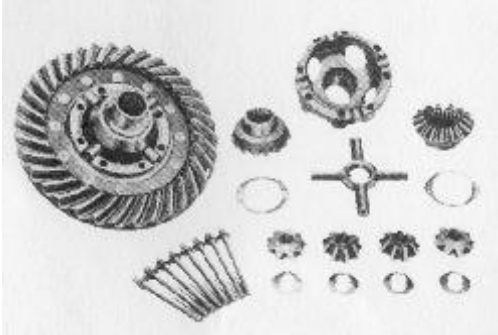
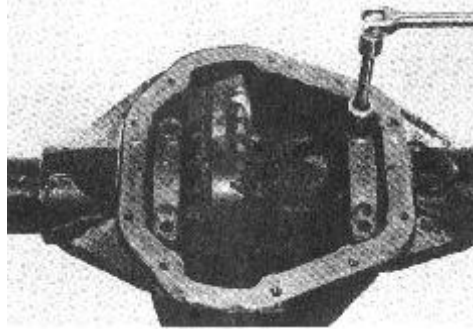

Step 3

Mark the differential case halves so they may be reassembled in their original position. Open the case. Remove and store the original differential components. Retain the original differential case, ring gear, and differential case bolts. Do not remove bearing cone assemblies from the case halves; do not remove the ring gear from the case half.

Step 4

Wash the differential case, ring gear, differential case bolts and bearing assemblies using a non-flammable, non-toxic cleaning solvent that will not etch, scratch or oxidize the components. Rinse in clean solvent and dry. Inspect for damage, wear or corrosion. *Replace if necessary with identical, axle/vehicle manufacturer approved components.*

NOTE:

Be sure all thrust washers have been removed from the differential case. Failure to do so will cause the NoSPIN differential to malfunction.

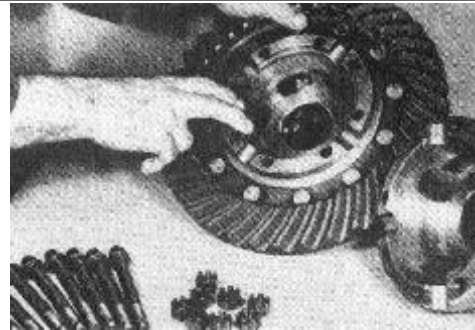

Step 5

Clean and examine the splined ends of the axle shafts. Remove any roughness or burrs with a tile or stone. Examine the shafts for straightness, cracks or other damage. Replace if necessary. Make sure splines on axle match the splines on NoSPIN differential side gear.

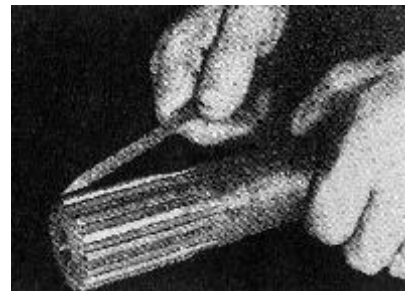

Step 6

Position the NoSPIN differential assembly in the case half which is attached to the ring gear.

CAUTION:

Do not remove the retainer bolt, nut and washers at this time. To do so will release the compressed springs, which can cause injury.

Step 7

Position the remaining differential case half over the NoSPIN differential.

NOTE:

Be sure both case halves are in the original (marked) position.

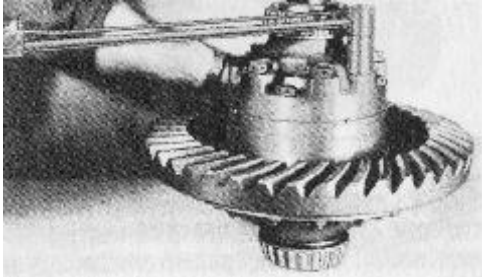
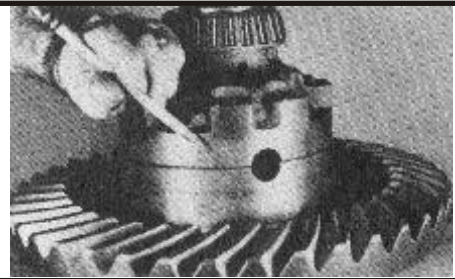
**Step 8**

Using a torque wrench, tighten the differential case bolts securely to the torque limit recommended by the vehicle/axle manufacturer's instructions. Assure that there is a tight fit between the spider trunnions and the case.

NOTE:

A loose fit between the spider and the case can cause malfunction of the NoSPIN Differential.

Step 9

Remove the retainer bolt, nut and washers. (Retain for future service work.)

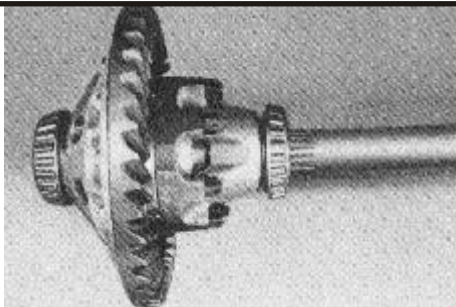
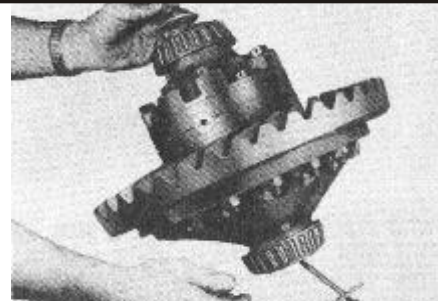
**Step 10**

Insert axle shafts into splined side gears of the NoSPIN differential. The shafts should slide in freely but fit correctly.

Step 11

Install the differential and ring gear assembly in the axle housing. Complete the reassembly of associated components as recommended by the vehicle/axle manufacturer's instructions.

NOTE:

Contamination, such as metal particles in the differential case, can cause the differential to malfunction. Be sure the axle housing is clean before proceeding.

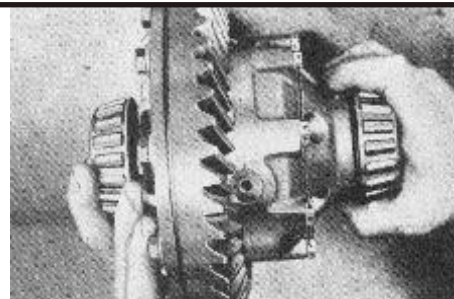
**Step 12**

Refill the axle housing with lubricant recommended for differentials by the vehicle/axle manufacturer.

Step 13

Apply Caution Label to instrument panel in full view of operator or mechanic. If you did not receive this label, contact Tractech's Marketing Department.

Step 14

Follow the test procedures outlined on page 12 to assure proper installation and operation of the NoSPIN differential.

NOTE:

If the NoSpin differential is disassembled, be sure to reassemble both clutch assemblies to the spider assembly with the 'slot' in each holdout ring over the long tooth of the spider.

INSTALLATION

Installation Instructions for NoSPIN/Detroit Locker Differentials - *Supplied with a Support Case*



Disassembly: (Steps 1-5)

Step 1

Refer to the vehicle/axle manufacturer's recommendations for removing the differential assembly from the axle. Ensure that all safety precautions are implemented.

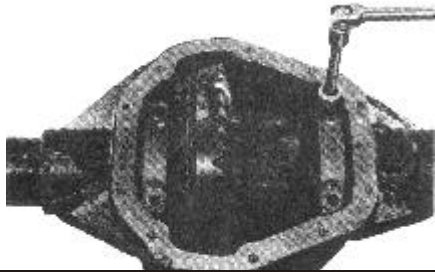

Step 2 Following the procedure recommended by the vehicle or axle manufacturer, remove the ring gear and differential case assembly from the axle carrier.

CAUTION:

Do not use heat to disassemble drive axles. To do so can destroy heat treat properties, weaken or distort axle components or result in a mishap which can cause injury, even death.

Step 3

Using the proper bearing puller, carefully remove the bearing cone assemblies from the original differential case. *Replace bearings if worn or damaged during disassembly.* If shims are used behind the bearing cone assemblies, record the amount of shim pack under each bearing.

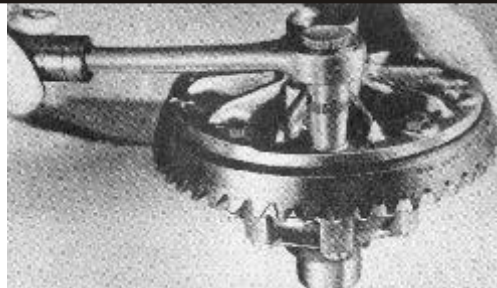

Step 4

Remove the ring gear from the original differential case. Record the dimension from the ring gear flange face to the nearest bearing shoulder. Record the dimension from one bearing face to the other.



Step 5

Store the original differential and case for use if the NoSPIN differential requires service. Protect parts from damage or Corrosion.



Step 6

Wash the ring gear, ring gear bolts, shims, and bearing races using a nonflammable, non-toxic cleaning solvent that will not etch, scratch or oxidize the parts. Rinse in clean solvent and dry. Inspect for damage, wear or corrosion. Replace if necessary with identical axle/vehicle manufacturer approved components.

Step 7

Clean and examine the splined ends of the axle shafts. Remove any roughness or burrs with a file or stone. Examine the shafts for straightness, cracks or other damage. Replace if necessary. Make sure splines on axle match splines on NoSPIN differential side gear.

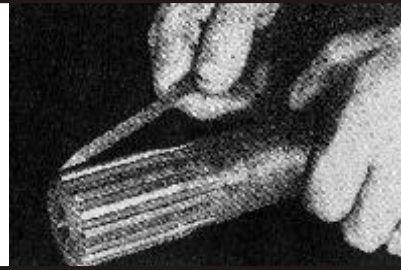

Step 8

If shims are used behind the bearing cone assemblies, measure the NoSPIN differential support case from the ring gear flange face to the nearest bearing shoulder and from one bearing shoulder to the other. Adjust the shim pack at each bearing journal to the dimension recorded previously from the original differential case.

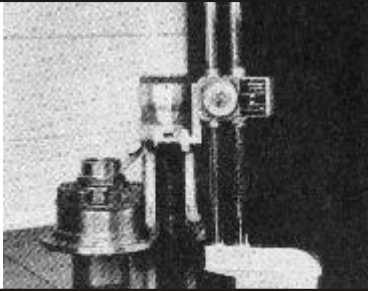

Step 9

Using a torque wrench, bolt the ring gear to the NoSPIN differential and case assembly. Tighten the ring gear bolts securely to the torque limit recommended by the vehicle/axle manufacturer.

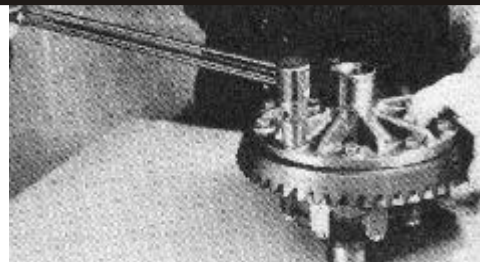

Step 10

Using an Arbor press with an arbor of the correct size, press the bearing cone and roller assemblies onto the hubs of the NoSPIN differential support case until they are properly and squarely seated.

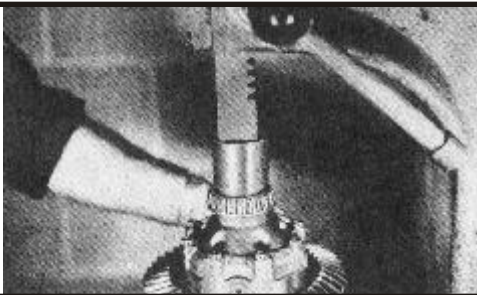

Step 11

Install the differential and ring gear assembly in the axle housing. Complete the reassembly of associated components as recommended by the vehicle/axle manufacturer's instructions. Note: Contamination, such as metal particles in the differential case, can cause the differential to malfunction. Be sure the axle housing is clean before Proceeding.

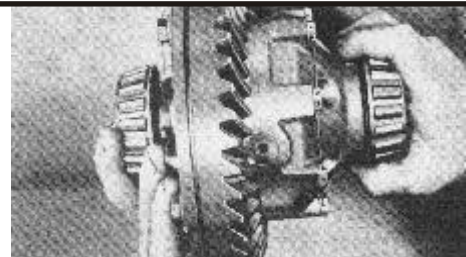

Step 12

Refill the axle housing with lubricant recommended for differentials by the vehicle/axle manufacturer.

Step 13

Apply Caution Label to instrument panel in full view of operator or mechanic. *If you did not receive this label, contact Tractech's Marketing Department.*

Step 14

Follow the test procedures outlined on page 12 to assure proper installation and operation of the NoSPIN differential.

NOTE: if the NoSPIN differential is disassembled, be sure to reassemble both clutch assemblies to the spider assembly with the 'slot' in each holdout ring over the long tooth of the spider.

TEST FOR PROPER INSTALLATION AND OPERATION

INSTALLATION TEST

Step 1

With the engine turned off, raise NoSPIN equipped driving axle(s) until all wheels are out of contact with any surface. Place the transmission in gear or park so that the driveshaft is locked and does not rotate.

NOTE: Test for forward disengagement:

Step 2

With two people, rotate both wheels rearward, as far as possible to lock both wheels.

Step 3

With the left wheel securely held in the rearward direction, rotate the right wheel slowly forward. A faint indexing or clicking sound should be heard as the NoSPIN disengages on the right side.

Step 4

With the right wheel slowly rotating forward, the left wheel should be rotated slightly forward. This will lock both wheels.

Step 5

Again, rotate both wheels rearward, as far as possible to lock both wheels.

Step 6

With the right wheel securely held in the rearward direction, rotate the left wheel slowly forward. A faint indexing or clicking sound should be heard as the NoSPIN is disengaged on the left side.

Step 7

With the left wheel slowly rotating forward, the right wheel should be rotated slightly forward. This will lock both wheels.

Repeat steps 2-7 except, test for *reverse disengagement*. If the above steps are completed successfully and rotating wheels disengage easily by hand, rotate freely and evenly, lock both wheels when required, and produce a faint indexing or clicking sound, then the NoSPIN is properly installed and is functioning correctly.

IF EITHER WHEEL DOES NOT ROTATE FREELY IN EITHER DIRECTION or does not lock both wheels as required, recheck the installation of the NoSPIN in the axle. Also check hand and foot brakes for possible drag caused by improper adjustment. Be sure that all thrust washers have been removed from the standard differential support case.

To check normal NoSPIN operation, drive the vehicle on a flat surface with good traction, in a right or left circle in forward and reverse to be sure that the outside wheel is free to overrun (i.e. that the outside tire does not scuff). A clicking or indexing sound may be heard. The sound of gear re-engagement may also be heard upon completion of the turn. This is normal.

OPERATION TEST

Check to see that both wheels of each NoSPIN differential equipped axle are driving. Make this test under load, so that engine torque is applied through the NoSPIN differential with the wheels on the ground. One way to achieve this load is to drive up against a solid obstruction (on loose dirt or gravel, if possible) and attempt to spin both wheels together. Perform this test in forward and reverse. (Exercise caution when performing this test to avoid damage to vehicle or obstruction.)

CAUTION: DO NOT OPERATE THE VEHICLE IF BOTH WHEELS OF A NoSPIN/DETROIT LOCKER EQUIPPED AXLE ARE NOT DRIVING. POWER TO ONLY ONE WHEEL CAN CAUSE SERIOUS STEERING PROBLEMS AND LOSS OF VEHICLE CONTROL AND RESULT IN A MISHAP WHICH CAN CAUSE PROPERTY DAMAGE, INJURY, EVEN DEATH.

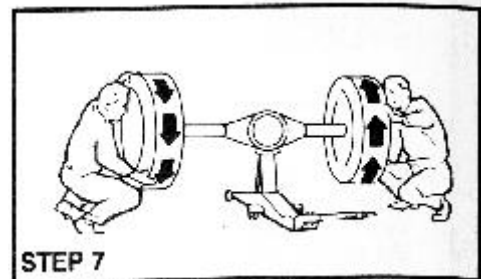
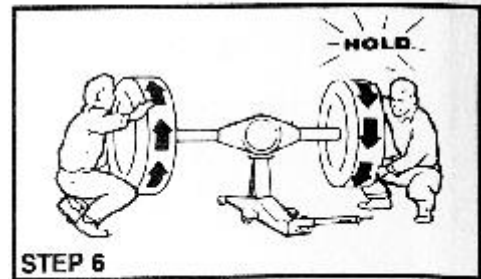
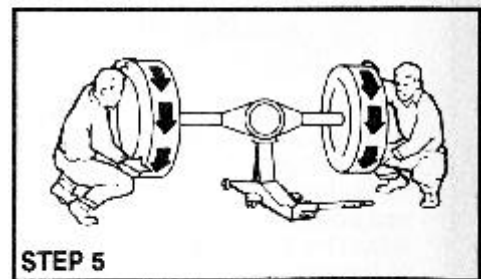
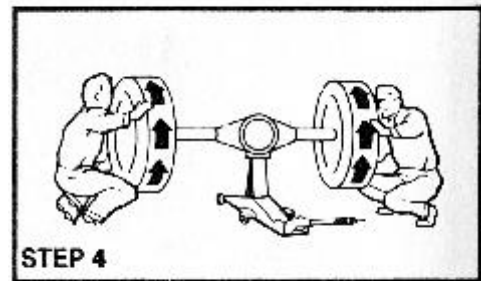
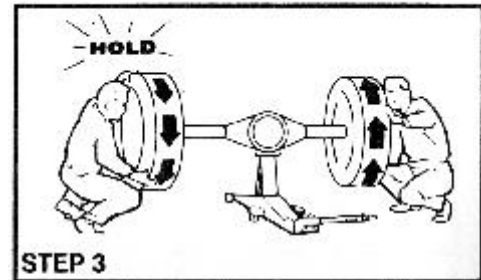
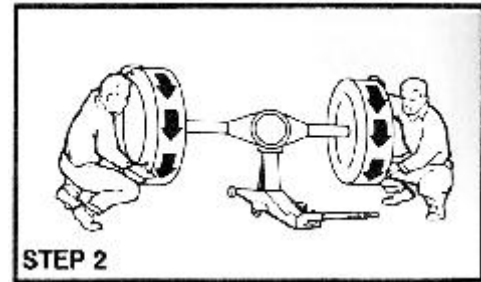

MAINTENANCE

Caution:

When servicing any driveline components of a NoSPIN differential equipped axle, ensure that the engine is switched off and all wheels are free of the ground to prevent the vehicle from moving. Axles equipped with NoSPIN/Detroit Locker differentials deliver power to both wheels - even when only one wheel is on the ground. Failure to observe these cautionary measures may cause the vehicle to move which can result in a mishap which can cause property damage, personal injury, even death.

Caution Label:

Vehicles equipped with NoSPIN differentials should be identified by a Caution label mounted on the instrument panel.

Lubrication:

All NoSPIN differentials are designed to operate in those lubricants recommended by the vehicle/axle manufacturer. No special lubricant is needed. For very cold weather applications, use the lightest oil the axle manufacturer will allow to overcome possible sluggish re-engagement of the driven clutch assemblies.

Routine Inspection

Carefully follow the recommended lubrication, preventative maintenance and inspection procedures of the vehicle/axle manufacturer as part of all NoSPIN differential preventative maintenance. Except for testing for proper operation, and a possible change in the way brake adjustments are made (as explained below), maintenance, inspection and lubrication requirements of NoSPIN differential equipped vehicles are the same as for vehicles with standard differentials.

Check for Proper Operation of NoSPIN Differential

At 90 day intervals, the drive axles should be raised and the NoSPIN differential checked (see page 12) to be sure it is operating properly. This test will also determine if both axle shafts are intact.

Adjustments

No adjustments or alterations should be made to the NoSPIN differential. Refer to the vehicle/axle manufacturer's instructions for adjustments to other components in the axle. When making brake adjustments, the wheels on both sides of the vehicle must be raised and the transmission placed in neutral so that the ring gear and opposite wheels are free to rotate with the wheels on the side being adjusted.

Servicing NoSPIN Differentials

Any decision to disassemble the axle for inspection should be made only after performing the installation and operation tests stated on page 12 and after consulting the vehicle/axle manufacturer's manual and determining that the NoSPIN differential, or some other axle component, is not working properly. Review the "Trouble shooting" section on pages 17-18 to determine whether the situation requires removal of the NoSPIN differential from the vehicle.

Removal of the NoSPIN Differential From the Axle

Refer to the vehicle/axle manufacturer's instructions. The procedure for removing the NoSPIN differential case and ring gear assembly is the same as for the original differential. It is not necessary to remove the ring gear from the differential case half unless the standard support case is being replaced or the NoSPIN, differential was supplied with a case manufactured by Tractech.

Retaining Bolt

A retaining bolt, washers and wing nut are useful to keep the NoSPIN differential assembly intact when removing it from the differential case and when reinstalling it in the axle housing.

CAUTION:

FAILURE TO USE A RETAINING BOLT OR SOME OTHER RESTRAINING MEANS WHEN SEPARATING THE DIFFERENTIAL CASE HALVES CAN CAUSE INJURY IN THAT NoSPIN DIFFERENTIALS HAVE COMPRESSED SPRINGS.

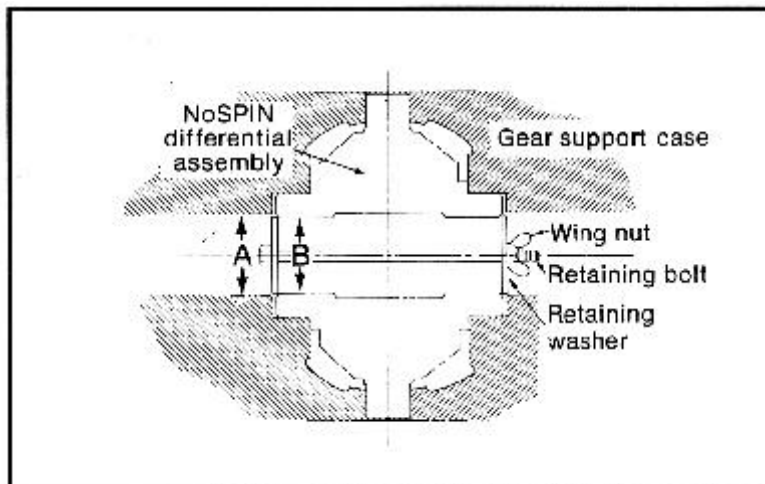

The bolt washers and wing nut used to retain the NoSPIN differential assembly when it was shipped from the factory as illustrated on page 13, are best for this purpose. You will note that the retaining washers must be small enough to pass through the case ends (dimension "A"), yet large enough to restrain the two side gears (dimension "B") and the balance of the NoSPIN differential assembly when all parts are assembled and the springs are compressed.

Disassembly of the NoSPIN Differential

1. Mark the differential case halves so they can be reassembled in their original position when repair or inspection is completed.
2. Insert the NoSPIN differential retaining bolt and washer assembly. Thread the nut fingertight against the washer (Fig 3) If a retaining bolt and washer assembly are not available, *hold the differential case firmly as the last bolts are being removed from the case halves to absorb spring pressure and prevent possible injury.*

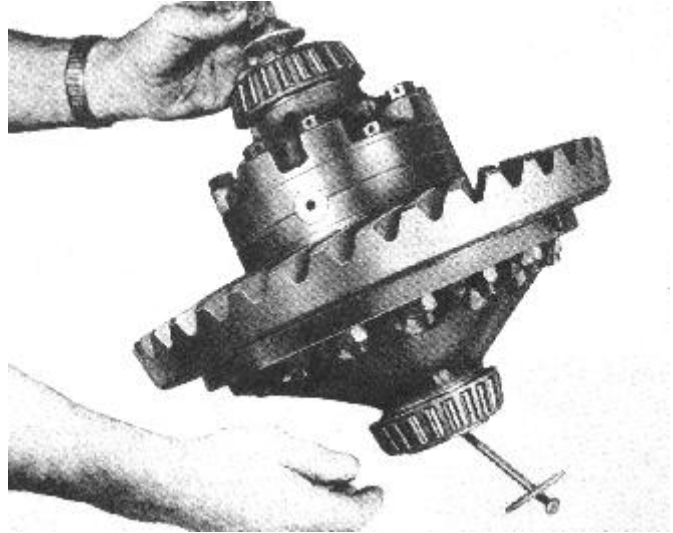

Fig. 3

3. Separate the case halves and remove the NoSPIN differential assembly.
4. Release the retaining bolt and washer assembly while firmly holding the NoSPIN differential to absorb the spring pressure.
5. Remove side gears, springs, spring retainers, driven clutch assemblies and spider assembly.

Inspection of Components

1. Wash all components thoroughly with a non-flammable solvent that will not etch, scratch or oxidize the parts. Rinse in clean solvent and dry.

2. Inspect the splines on the driven clutches. Remove any burrs or small chips with an abrasive stone or electric burr grinder. If sections of the spline are broken away, replace the components.

Inspect the teeth on the driven clutches. If wear or chipping is present, replace the component. *Check holdout rings for fractures and chipping or excessive wear of the lugs. Replace as required.*

NOTE: The holdout ring and driven clutch are serviced as an assembly.

3. Inspect the teeth on the spider and center cam. If wear or chipping is present, replace the component. *Check the center cam for free movement.*

NOTE: The spider and center cam are serviced as an assembly.

4. Inspect the splines on the side gears. Remove any burrs or small chips. If splines are broken or badly chipped, or if hub walls are fractured, replace the component. Inspect the side gear spline fit on its mating axle shaft. Be sure the splines do not bind.

5. Check the spring load at the operating height. (See chart on page 16)

6. Carefully examine the differential case. If worn or scored, the case should be replaced.

7. Examine the bearings, ring gear, ring gear bolts and nuts. Replace if necessary with new components that meet the vehicle/axle manufacturer's specifications.

CAUTION:

If major components (e.g. spider assembly or driven clutch assemblies) show excessive wear, the complete NoSPIN differential should be replaced. If a component is replaced, mating components should also be replaced in that it is likely that they too are damaged. Use of worn or damaged components can lead to a recurrence of the original problem. NOTE: Use only Tractech approved components when repairing NoSPIN/Detroit Locker differentials.

Reassembly Procedure for NoSPIN Differentials

1. Assemble a spring retainer over the side gear splines with the retaining lip pointed up. It should seat against the side gear shoulder. Place a spring over the side gear spline and against the retainer lip with the smaller diameter of the spring against the retainer (Fig. 4).

Fig. 4

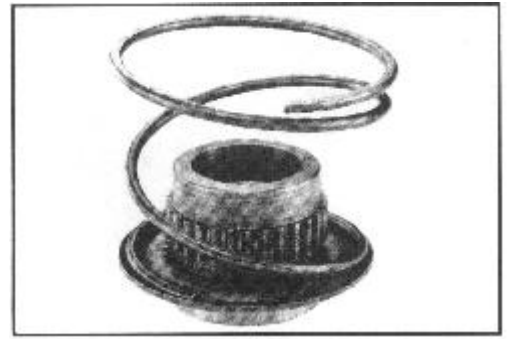

NOTE: Verify that the spring is functioning freely. Be sure the spring is not binding, that the coils do not overlap and that there is good contact between the coil and the spring retainer.

2. Assemble the two clutch assemblies to the spider assembly.

IMPORTANT:

Be sure the 'slot' in each holdout ring is properly aligned over the long tooth of the spider assembly.

3. Position the spider assembly and clutch assembly on top of the spring.

4. Assemble the other retainer and spring on the other side gear as previously indicated, and position on top of the spider and clutch assembly.

5. Using a mechanical press (or other safe means) compress the springs and fasten the NoSPIN together with a retaining bolt, washers and wing nut (Fig. 5). Be sure the side gear splines are completely meshed with the clutch spline.

Fig. 5

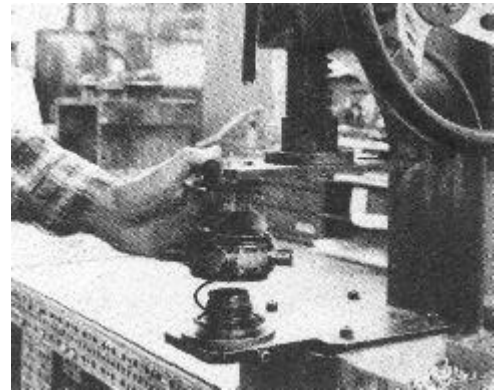

CAUTION:

Failure to use a retaining bolt or some other restraining means when assembling the NoSPIN can cause injury in that all NoSPIN differentials have compressed springs.

6 Lay the ring gear and flanged half of the differential case on a bench with the bearing end of the case hub down and the inner case facing up. ENSURE NO THRUST WASHERS ARE INSIDE THE CASE.

7. Install the NoSPIN differential in the flanged differential case half.

8. Mount the plain case half over the side gear. ENSURE NO THRUST WASHERS ARE INSIDE THE CASE.

9. Position the case halves firmly together with the punch marks aligned and install the case bolts.

10 Tighten case bolts to the torque specified by the vehicle/axle manufacturer. Check to be certain of a tight fit between the two case halves at all points and between the trunnion mounts in the case and the spider trunnions (Fig. 6).

Fig. 6

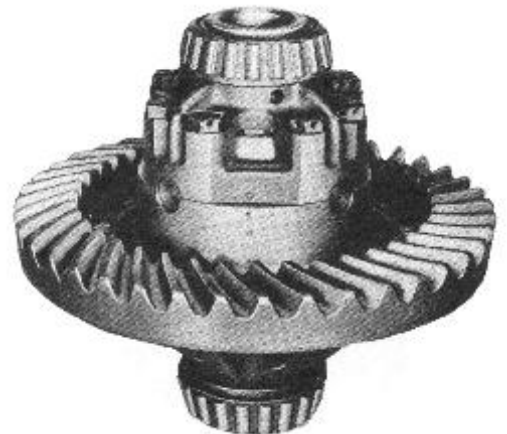

11. Remove the wing nut, washers and retainer bolt.

12. Follow the vehicle/axle manufacturer's instructions for reinstallation of the ring gear and differential case assembly into the axle carrier.

13. BEFORE OPERATING THE VEHICLE PERFORM INSTALLATION AND OPERATION TEST STATED ON PAGE 12 TO ENSURE CORRECT RE-ASSEMBLY OF COMPONENTS.

SPRING LOAD (in lbs. Minimum) AT OPERATING HEIGHT

Spring load should be checked at the operating height specified in the above table for an approximate reading. A dial indicator type spring tester is the best tool for this procedure. However, if one is not available, a weight equal to the load specified in the table can be placed on the spring and the height can be measured with the weight in place on the spring. Tech Data Report #80-1038 can be used to assist in making a decision as to whether the spring should be replaced.

Model Series	Part No.	Operating Height	Load (lbs. Minimum)
137S	69978	.45"	40
162S	69427	.54"	45
187S	68264	.61"	46
187S	69076	.61"	72
187S	72008	.61"	72
187S	72016	.61"	72
225S	66622	.73"	53
225S	69640	.73"	52
250S	67085	.62"	61
275S	67115	.86"	69
306S	66842	.90"	104
350S	67204	1.04"	101
400S	65461	1.41"	144
450S	64718	1.30"	162
550S	65423	1.43"	198
600S	68707	1.56"	297

TROUBLE SHOOTING

An important function of an owner/operator in the field is that, one of the many hats he is required to wear is the one labeled "trouble shooter." Trouble shooting can be a very frustrating, elusive job. However, if some basic rules are followed in a systematic order, solutions can be easily obtained. The following guidelines can be utilized for trouble shooting both on and off highway vehicle applications. However, some techniques used for on/highway vehicles are not as important for off/highway vehicles:

1. Before tearing down an axle and differential make sure you get the correct "story" from a reliable source. Then actually try the vehicle yourself, Inspect any previously remove components, Question associated failures, ask if it has occurred before. In other words, get the facts. And don t over-react.
2. Read the Trouble Shooting Section. (Enclosed)
3. Perform a Functional Check. (Enclosed)
4. Check tire rolling radii. Assure that all tires are within specifications. (This applies primarily to on/highway vehicles.)
- 5 If all the previous checks do not reveal the problem or offer a solution, then the NoSPIN must be removed. Upon removal, look for the following:
 - A. Contamination in the oil or on the components.
 - B. Obvious broken or worn parts.
 - C. Mis-assembly...i.e., retainers installed backwards, thrust washers left in, spring jumping over retainer, etc.
 - D Heavy wear on spider and clutch drive teeth... i.e., Tooth rounding, 5° negative angle gone, corner chipping of teeth. (These components are usually the main areas of wear.)
 - E. Telltale signs of eccentric wear, patterns on components, indicating possible cause of shaft problems.
 - F. Check NoSPIN assembly for pair-up, hand cam, H.O.R. tension, backlash, etc.
- 6 After inspection of the NoSPIN and associated axle components a new unit should be installed and a complete functional check and vehicle performance check should be made.
- 7 If during the visual inspection a solution to the problem is not obtained, the unit should be returned to Tractech attention of the Customer Services Manager. Call first for a return authorization number.

The following chart will assist owners and operators of NoSPIN differential equipped vehicles diagnose and correct problems related to vehicle performance. Potential problems are stated on the left; possible causes for those problems are listed, by number, on the right. The explanation of these "possible causes" follows on page 18.

PROBLEM	POSSIBLE CAUSE														
	1	2	3	4	5	6	7	8	9	10	11	12	13	14	15
Hub studs shearing; rear tire scuffing; axle shaft breakage	●	●			●			●	●					●	
Steering difficulty; vehicle pulls on straight forward driving or tends to go straight when making turns	●	●	●	●	●		●		●				●	●	
No differential action; binding in turns	●			●	●	●			●					●	●
Excessive driveline noise*	●	●	●	●	●		●		●					●	
Excessive tire wear	●	●	●	●	●	●	●							●	●
Grinding noises	●			●	●			●	●	●				●	
Continuous "clicking" sound in straight forward driving	●	●	●		●										
Excessive backlash in vehicle drivetrain; engine lug or vehicle surge during turns	●					●		●		●					
Tendency to side-slip or "fishtail" on icyroads											●				
Sluggish reengagement of NoSPIN differential clutch assemblies									●			●			
Difficulty in turning vehicle from standing start	●			●	●								●	●	
Erratic operation of NoSPIN differential; premature wear or failure of NoSPIN differential components	●	●	●	●	●			●	●	●		●		●	

TROUBLE SHOOTING

* NOTE: NoSPIN differentials will emit occasional "metallic" sounds due to backlash built into the unit. This is normal! See backlash under Vehicle Performance on pages 4.

Possible Causes for Vehicular Problems

1. Improper installation; defective NoSPIN differential. Follow test procedures outlined on page 12 Correct installation or repair or replace the NoSPIN differential if the vehicle fails any step of the test procedure.
2. Overloading and/or improper weight distribution. Remove excess weight and redistribute the load from side to side, according to the vehicle/axle manufacturer's instructions.
3. Unequal rolling radii of the drive wheel. A smaller rolling radius tire will cause the tire to overrun constantly when power is applied. The other tire (with the larger rolling radii) will do all the driving replace tires or adjust tire pressures until rolling radii are equal.
4. Broken axle shaft. Replace. NOTE: It is possible to operate a NoSPIN equipped vehicle on one axle shaft. However, this practice is not recommended in that serious damage can occur to other axle components.
5. Bent axle shaft or housing; axle shafts on different center lines. Replace bent axle shafts or housing or realign hub faces and bolt circles in both the differential carrier and axle housing.
6. Larger than normal steering angle; short turning radius. Vehicles designed with high turning angles may surge, have steering difficulty and cause tire wear during sharp turns. Reduce maximum turning angle and have the driver decelerate when engine surge begins.
7. Incorrect wheel alignment. Correct as required.
8. Worn or defective axle components. Check the condition of the ring gear, pinion gear, bearings, seals, etc. Replace as required.
9. Foreign matter in axle housing or improper assembly of axle components. Inspect for contamination. Check assembly of axle components.
10. Incorrect ring and pinion adjustments; worn driveline components (transmission gears, U-joints, etc). Replace or adjust components as required.
- 11 High crown in road; poor traction surface under all drive wheels. The tendency to side-slip or "fishtail" on icy roads sloping toward the curb is more pronounced when using a traction differential than when using a conventional differential. Stability can be retained when side-slip occurs by decelerating (letting off the accelerator). CAUTION: Do not apply the brake. To do so may result in loss of vehicle control.
- 12 High Viscosity Lubricant. In very low temperatures, gear lubricant can thicken and impede the normal function of the NoSPIN differential. Tractech recommends that the axle oil be changed for very cold weather operation to the lightest acceptable lubricant allowable by the axle/vehicle manufacturer Heat control devices, garaging and a warm up period may also provide relief from this problem in extreme low temperatures.
- 13 Low steering cylinder pressure, undersized steering cylinder, excessive angle of articulation, excessive vehicle weight. Correct as required.
- 14 Improper application of product. Review application guidelines on pages 3.
- 15 Insufficient front axle overrun ratio (lead) for (arm tractors (straight frame with front wheel assist power) Take physical measurement, increase to minimum of plus three (+3) percent by increasing tire pressure in front tires and/or reducing tire pressure in rear tires, within the tire manufacturer's recommendations.

NEW IMPROVED DETROIT LOCKER DIFFERENTIAL

SPECIAL INSTRUCTIONS

TO IDENTIFY

New IMPROVED Detroit Locker differential models in the 187S and 225S series' have an "L" added to the model number, such as 187SL-16A. They replace the previous model.

APPLICATIONS

These units are designed for light trucks including 2 wheel drive and 4 wheel drive vehicles and high performance passenger cars.

VEHICLE PERFORMANCE

Performance is similar to that of NoSPIN/Detroit Locker - equipped light trucks, pages 3-4. The new IMPROVED Detroit Locker operates in the drive - coast mode without the familiar harsh feel and sound. Everyday driving is quieter and smoother, yet maximum traction is immediately available.

EXPLODED VIEW

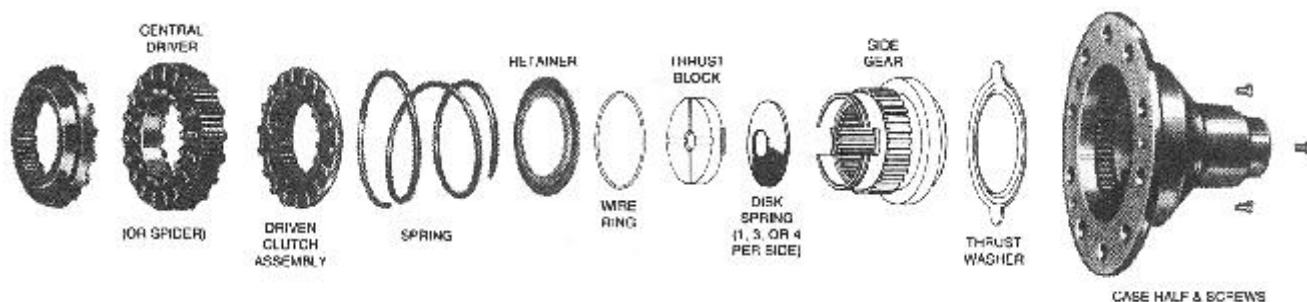

Note the additional parts compared to NoSPIN/Detroit locker differentials, page 5. New IMPROVED Detroit Locker models are supplied with either a spider or central driver and a support case.

OPERATION

Operation is identical to that of NoSPIN/Detroit Locker - equipped vehicles, page 6.

INSTALLATION

Installation of a new IMPROVED Detroit Locker is similar to that of a NoSPIN/Detroit Locker differential, pages 7, 10 and 11. Important: Thrust washers are supplied installed inside the support case. The instructions on pages 8, 12 and 15 to "Be sure all thrust washers have been removed" DOES NOT APPLY to the two thrust washers supplied with the new IMPROVED Detroit Locker models.

Caution: If for any reason the thrust washers supplied have been removed from the support case halves supplied, reinstall only the two thrust washers supplied by Tractech by locating the tabs in slots, with the oil groove facing you.

Caution: If for any reason the new IMPROVED Detroit Locker unit is disassembled, reinstall the disc (Belleville) springs - there will be one, three or four on each side - with the large diameter against the side gear.

Be sure to install the Caution label and this Manual in the vehicle.

TEST FOR PROPER INSTALLATION AND OPERATION

Perform this test as described on page 12.

MAINTENANCE

Follow the instructions and cautions as described on pages 13-16 except that the instruction on page 16 to "Be sure all thrust washers have been removed" DOES NOT APPLY to the thrust washers supplied with the new IMPROVED Detroit Locker models.

TROUBLE SHOOTING

The help provided on pages 17-18 apply to the new IMPROVED Detroit Locker differential.

NEW Detroit C-LOCKER™ DIFFERENTIAL

SPECIAL INSTRUCTIONS

Detroit Lockers for C-Clip retained axles in the 187 and 225 series have a "C" instead of an "S" in their model number, such as 187C-145A.

APPLICATIONS

These units are designed for light trucks including 2-wheel-drive and four-wheel-drive vehicles, and high performance passenger cars.

VEHICLE PERFORMANCE

Performance is identical to that of NoSPIN/Detroit Locker - equipped vehicles, page 4.



EXPLODED VIEW

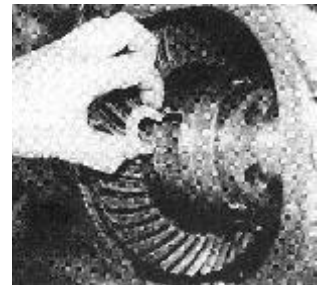
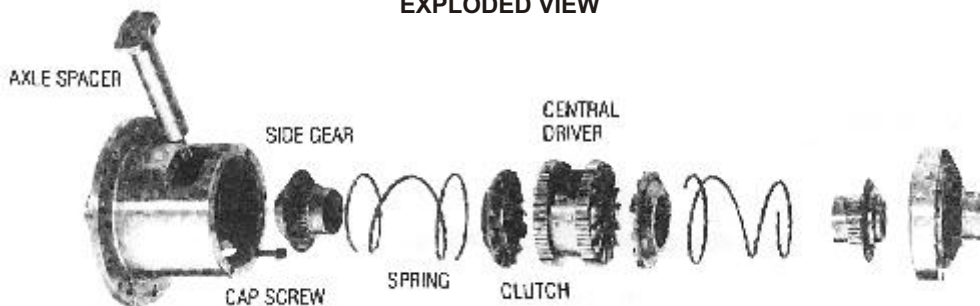

C-Clip Installation

OPERATION

Operation is identical to that of NoSPIN/Detroit Locker - equipped vehicles, page 6.

INSTALLATION

Installation of a Detroit C-Locker for differential is similar to that of a Detroit Locker differential, pages 7-11 up to Step 11. The following steps must be carried-out before proceeding to Step 12.

Step 11a Install the differential and ring gear assembly in the axle, setting pre-loaded and backlash per the vehicle manufacturers instructions Note: Contamination, such as metal particles in the differential case, can cause the differential to malfunction. Be sure the axle housing is clean before proceeding.

Step 11b Install the C-Clip as in the conventional differential utilizing the window in the side of the differential case.

Step 11c If the plain side (the side opposite the ring-gear side) bearing cap has already been installed, it will be necessary to remove it before proceeding.

Step 11d Install the spacer pin (in plastic bag) through the case and between the ends of the axle shafts.

Step 11e Insert the long socket-head cap screw (in plastic bag) through the differential plain-side cover and thread into differential housing. The end of the screw will engage the hole in the spacer pin thus holding it in place. Torque the screw to 23-25 ft.-lbs. (31-34Nm). Note: this screw has a thread locking patch pre-applied to it. If for any reason it is removed after installation, a thread locking compound must be re-applied before reassembly.

Step 11f Install the plain-side bearing cap and torque per the vehicle manufacturer's instructions. Bearing cap bolts must have a thread locking compound applied to them.

Step 11g Complete the reassembly of the associated components as recommended by the vehicle manufacturer's instructions.

Complete Steps 12,13, and 14 on page 9. Be sure to install Caution Label and this Manual in the vehicle.

TEST FOR PROPER INSTALLATION AND OPERATION

Perform this test as described on page 12.

MAINTENANCE

Follow the Instruction and Cautions as described on pages 13-16.

TROUBLE SHOOTING

The help provided on pages 17-18 apply to the Detroit C-Locker for C-Clip retained axles.

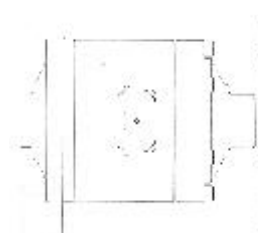
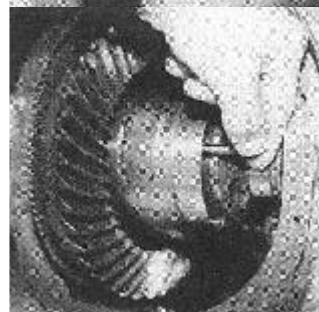
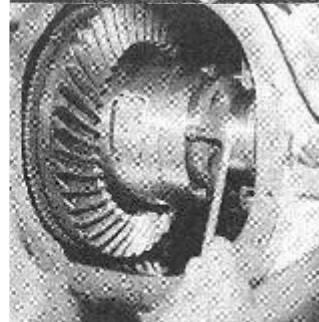
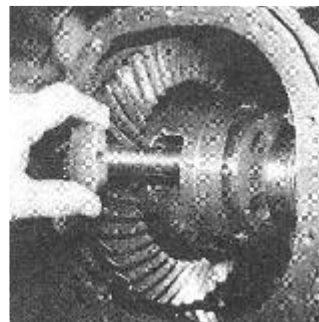

GLOSSARY

ARTICULATED - Refers to vehicles that are joined in the middle and turn around this joint, as in "articulated farm tractor."

AXLE CARRIER - The differential and ring and pinion gears are mounted on the axle carrier; the "center section" of the axle housing.

AXLE GEAR RATIO -The ratio between the number of teeth on the ring gear and the number of teeth on the pinion gear (e.g., 3.92:1.00).

AXLE HOUSING -The support member of the axle which sustains the weight of the vehicle and houses the axle carrier assembly.

BACKLASH - The designed clearance between mating components in the driveline (e.g., Gear sets, spline couplings, etc.).

CASE ASSEMBLY - The differential housing (usually consisting of two case halves; contains the differential assembly).

CASE BEARING (CARRIER BEARING) -The bearings that mount to the hubs on the differential support case.

CASE PILOT BORE - The locating diameter in the differential case from which the differential side gear is installed.

CENTER CAM - The control element of the NoSPIN differential. The center cam is used to lift the drive members from engagement by means of cam ramps.

CENTRAL DRIVER - An outer splined member (similar to the spider) having torque carrying teeth on both sides; the "center piece" of the NoSPIN differential.

CLUTCH PACK DIFFERENTIAL - A limited-slip differential which uses friction clutch plates and/or springs to partially reduce wheel spin.

DETROIT LOCKER DIFFERENTIAL - Trademark given to "light duty" NoSPIN differentials. (NoSPIN and Detroit Locker are operationally identical.) Manufactured by Tractech.

DIFFERENTIAL - Axle gear assembly which allows one axle shaft and wheel to turn slower or faster than the other when negotiating a turn.

DIFFERENTIATION - The different rate of speed between two wheels of an axle when making a turn or over uneven surfaces.

DRIVELINE - Components used to propel the vehicle driveshaft and universal joints, transmitting torque from transmission to drive axle (same as drivetrain).

DRIVEN CLUTCH - Member that is used to provide torque to another member, such as to the side gear. Each NoSPIN differential has two driven clutches.

DRIVETRAIN - A series of components which transmit power from the engine to the wheels/tires (i.e., transmission, propeller shafts, transfer case, axle, differential, shafts, etc.).

DOUBLE REDUCTION - Dual gear reduction used in rear axles.

FISHTAILING - Side slipping of the vehicle caused by traction instability.

G.C.W. - Gross Combination Weight. G.V.W. plus vehicle weight and payload of towed vehicle. G.V.W. - Gross Vehicle Weight. Total weight of vehicle and payload.

GEAR SUPPORT CASE - Case used to support the differential. Same as case assembly.

GROUND COEFFICIENT-The horizontal force required to move a body, divided by the weight of the body. The amount of friction at the ground; the "quality" of the ground surface (e.g., ice, snow, dirt, etc.).

HELICAL - "Angled" gear tooth form.

HOLDOUT RING - Ring which assembles to NoSPIN differential clutch; maintains clutch disengagement in a turning mode.

INDEXING - A passing of one member over another, causing a slight audible sound from their contact (usually associated with NoSPIN differential).

INPUT TORQUE- Measurement of available power.

LEAD RATIO - On unequal wheeled four wheel drive tractors the transmission is so geared that any difference in road speed of the two axles results in a faster speed for the front wheels (lead or overrun), this prevents the front wheels from being pushed.

LIMITED-SLIP DIFFERENTIAL - A differential which utilizes some means of partially reducing, but not totally eliminating, individual wheel spin (e.g., clutches, springs, biasing pinion gears, etc.).

LOCKING DIFFERENTIAL- A differential that provides a locked axle condition. Can be manual or automatic, as in hydraulic locking differential or NoSPIN differential.

MACHINED SPLINES - Splines that have been manufactured by shaping, hobbing, broaching, or slotting.

NoSPIN DIFFERENTIAL -Trademark of automatic, positive-locking differential. Manufactured by Tractech.

OVERRUN RATIO - On unequal wheeled four wheel drive tractors the transmission is so geared that any difference in road speed of the two axles results in a faster speed for the front wheels (overrun or lead), this prevents the front wheels from being pushed.

PARALLEL SPLINES - Series of parallel keys cut along the axle shaft which mate with corresponding slots in the differential side gear.

PAYLOAD - Actual weight of useful cargo carried by vehicle.

PINION (INPUT) GEAR - The gear that is directly connected to the driveshaft which propels the differential and ring gear and provides power to the axle.

PLANETARY AXLE - Axle having a gearset arrangement in a concentric pattern; consisting of a sun gear surrounded by pinion gears which mesh with an annulus ring gear. This gearset provides torque multiplication in a reduced area on the same center line as the axle shaft usually located on the hub ends of axle.

PRE-LOAD - Differential bearing adjustment achieved by adding or subtracting shims.

R.P.M. - Revolutions Per Minute. Term used to define rotation.

RING GEAR - The gear that is attached to the differential case and driven by the pinion gear.

ROLLED SPLINES - Splines that are manufactured by use of rolling dies to form the spline configuration.

SHIM - "Spacer" used to achieve differential bearing adjustment.

SIDE GEAR - The gear that is mounted in the differential case; has the axle shaft splined to it; driven by the pinion gear.

SINGLE SPEED - Axle or transfer case having a single gear ratio.

SHOCKLOAD - A force caused by sudden impact.

SPIDER-The "center piece" of a standard, clutch pack or NoSPIN differential; having a spider-like shape.

SPIDER CROSS - Two or four armed member used to mount the standard differential pinion gears.

SPIDER GEAR(S) - Bevel pinion gears that are mounted on spider cross that drive the side gears of standard or clutch type differentials.

SPLINES - "Teeth" on axles that mate with "teeth" (splines) on differential side gear.

SNAP RING - A circular expandable ring that is used to retain two members together, as the snap ring in a NoSPIN differential that retains the spider and center cam.

STANDARD DIFFERENTIAL - Open or conventional differential with no means of traction control.

TAG AXLE (TANDEM) - Non-powered rear axle which follows drive axle. Provides additional load carrying capacity and distribution.

TAPERED SPLINES - Cone shaped spline configuration.

THRUST BLOCKS - Support mechanism used to prevent ring and pinion gear deflection.

THRUST WASHER - Used in conventional differential to reduce wear to the support case.

TORQUE - Force having a twisting or turning effect. Also used in conjunction with the term "power."

TRUNNION - Journals allowing pivoting or turning, such as on a spider cross. On a NoSPIN differential, the arm (there are four) which supports the differential in the case assembly.

TWO-SPEED - Axle or transfer case having two selective gear ratios.

UNDERSTEER - The condition of steering when making a turn that causes the vehicle to go straight rather than turn freely.

WHEELBASE - Distance between center lines of front and rear axles or to the center line of tandem axles.

TRACTECH DIFFERENTIAL LIMITED WARRANTY, AND LIMITATIONS

Tractech (TRACTECH) expressly warrants each TRACTECH product or part to be free from defects in materials and workmanship under NORMAL USE AND SERVICE.

A. Differentials

1. In new vehicles

a. For licensed vehicles, when not used in competition of any type, for the lesser of: 1) the same period (of time, mileage or hours of use) as the other drive axle parts are warranted by the axle manufacturer in that vehicle or 2) one year from date of delivery or 100,000 miles of differential use by the first user; or

b. For non-licensed vehicles, for the same period (of time, mileage or hours of use) as the other drive axle parts are warranted by the axle manufacturer in that vehicle.

2. In used vehicles

a. For licensed vehicles, when not used in competition of any type, for the earlier of 100,000 miles of differential use or one year from the date of delivery to the first user; or

b. For non-licensed vehicles, for the same period (of time, mileage, or hours of use) remaining, if any, as the other drive axle parts are warranted by the axle manufacturer in the vehicle.

3. For vehicles used in competition of any type, for 30 days from the date of delivery to the first user.

B. Clutches and Brakes For six (6) months from date of delivery.

There exist specific MANUALS for each TRACTECH differential indicating the appropriate application, operation inspection and maintenance criteria. IT IS MOST IMPORTANT THAT ANY SELECTOR, PURCHASER, INSTALLER, MAINTAINER OR USER CAREFULLY READ the relevant MANUAL before any application is selected or any operation or maintenance is attempted.

Also TRACTECH strongly encourages each designer, prospective customer or user to submit an application approval request using TRACTECH Differential Application form 7003, Clutch Application form 3003, or Brake Application form 8003 as applicable.

NORMAL USE AND SERVICE means that:

A. The product or part will be applied, installed, operated, inspected and maintained in accordance with the TRACTECH Operation and Maintenance Manual, and Owner's Manuals for the specific product;

B. The maintenance of the product must meet or exceed the level specified by the vehicle or equipment manufacturer for the TRACTECH product or similar product; and

C. The product will be applied and operated within the boundaries of any written TRACTECH APPLICATION APPROVAL by the TRACTECH Engineering Department.

EXCLUSIONS

THE FOREGOING WARRANTY IS EXCLUSIVE, AND IN LIEU OF ALL OTHER WARRANTIES, EXPRESS OR IMPLIED (WHETHER ORAL OR WRITTEN), INCLUDING BUT NOT LIMITED TO ANY IMPLIED WARRANTY OF MERCHANTABILITY OR FITNESS FOR ANY PARTICULAR PURPOSE. No person, including any dealer or representative of TRACTECH, except the President of TRACTECH, is authorized to make any representation or warranty concerning TRACTECH products on behalf of TRACTECH or to assume for TRACTECH any obligation not contained in this warranty, including a warranty of fitness for any particular purpose. This warranty gives you specific legal rights and you may also have other rights which vary from state to state. ANY IMPLIED WARRANTIES, INCLUDING THE IMPLIED WARRANTY OF MERCHANTABILITY OR FITNESS FOR A PARTICULAR PURPOSE, TO THE EXTENT THE SAME CANNOT BE DISCLAIMED UNDER APPLICABLE LAW ARE LIMITED IN DURATION TO THE EXPRESS WARRANTIES SET FORTH ABOVE EXCEPT IN THOSE STATES THAT DO NOT ALLOW TIME LIMITATIONS ON IMPLIED WARRANTIES. THERE IS NO IMPLIED WARRANTY OF MERCHANTABILITY OR FITNESS FOR A PARTICULAR PURPOSE OR ANY PURPOSE WHEN THE PRODUCT IS PUT TO AN INDUSTRIAL, COMMERCIAL OR RENTAL USE.

In no event does any warranty, express or implied, apply to loss, harm or damage to the extent caused by any or all of the following; wear to or failure of other drive train parts; freight damage; use of components, parts and/or accessories not obtained from or approved by TRACTECH or which do not meet TRACTECH quality and performance specifications; improper installation, maintenance, repair, misuse, or abuse, normal wear of moving parts or components affected by moving parts; and/or unauthorized alterations or Modifications.

TRACTECH SHALL NOT BE LIABLE FOR ANY INCIDENTAL, CONSEQUENTIAL OR SPECIAL DAMAGES (i.e. Broken ring & pinion, axles, bearings, differential covers, towing & labor charges) OR EXPENSE ARISING DIRECTLY OR INDIRECTLY FROM A DEFECT IN PRODUCTS MANUFACTURED OR SOLD BY IT OR FROM THE USE OF ANY SUCH DEFECTIVE PRODUCT, INCLUDING BUT NOT LIMITED TO DAMAGES, EXCEPT TO THE EXTENT THAT EXCLUSION OR LIMITATION OF INCIDENTAL OR CONSEQUENTIAL DAMAGES IS PROHIBITED BY APPLICABLE LAW.

TRACTECH RESERVES THE RIGHT TO MAKE CHANGES IN DESIGN AND OTHER CHANGES, MODIFICATIONS, ALTERATIONS OR IMPROVEMENTS TO ANY OF ITS PRODUCTS WITHOUT THERE RESULTING ANY OBLIGATION UPON TRACTECH TO FURNISH OR INSTALL THE SAME UPON ANY PRODUCTS PREVIOUSLY SOLD AND DELIVERED OR PRODUCTS THEN IN PROCESS, MANUFACTURE OR DISTRIBUTION.

LIMITATION OF REMEDIES

At TRACTECH'S option, TRACTECH will credit the buyer's account for the purchase price of, or repair or replace without charge for materials, any TRACTECH product that failed within the warranty period that is finally determined by TRACTECH to have been defective in material or workmanship.

Any suit or action arising out of or relating to this Warranty, or the breach thereof, must be commenced within one (1) year after the cause of action has accrued. The foregoing shall not limit the time within which any suit or action must be brought to collect an amount agreed to be paid by the buyer or to enforce a judgement for or to collect any such amount.

It is expressly agreed that the liability of TRACTECH is limited, and TRACTECH does not function as an insurer. All buyers of TRACTECH products waive subrogation on all claims covered under their own or any other insurance.

If TRACTECH should be found liable to anyone on any theory (except breach of any express warranty, where the exclusive remedy is as set forth above), the liability of TRACTECH shall not exceed the purchase price of the involved TRACTECH product (or service) when sold (or when service is performed) by TRACTECH to the first buyer. THE REMEDIES SET FORTH HEREIN ARE EXCLUSIVE AND ARE IN LIEU OF ALL OTHER REMEDIES, EXPRESS OR IMPLIED, regardless of theory, cause or origin of any loss, harm or damage resulting directly or indirectly to any person, organization, entity or property, including without limitation: the performance or non-performance of any obligation set forth in this Warranty; breach of any agreement (oral or written including specifications) between TRACTECH and its customer or the buyer; negligence, active, passive or otherwise, of TRACTECH or any of its distributors, agents or employees; breach of any warranty or covenant implied or imposed by law; misrepresentation; and/or strict liability.

The sole purpose of the stipulated exclusive remedies shall be to provide the buyer with a credit or replacement for, or the repair of, defective products or services in the manner provided herein. The exclusive remedies shall not be deemed to have failed of their essential purpose so long as TRACTECH is willing to credit the buyer's account for the purchase price of, provided replacement for, or repair, the defective products or services in the manner prescribed herein.

ADJUSTMENTS

When adjustment is sought under this Warranty, a claim should be made within six (6) months of the date of failure, as follows:

A. Users in North America

1. If the product or part was purchased installed by the original equipment manufacturer (or its dealer), follow the manufacturer's procedures for warranty claims; or

2. If the product or part was purchased through a distributor of TRACTECH products, have the distributor write or phone TRACTECH Customer Service Department and ask for an Authorization to Return Material number. Supply the distributor with all requested information. Have the distributor ship the entire product (freight prepaid) to our Warren, Michigan factory. Evaluation of claims take 4-6 weeks from the time the unit is received.

B. OEM's in North America Contact TRACTECH to receive a written Authorization to Return Material with number.

Then return material to TRACTECH (freight prepaid) and include a copy of Authorization to Return Material and reason for return. NOTE: At the option of TRACTECH, material may not need to be returned, but written confirmation must be obtained prior to TRACTECH'S approval of a credit memo.

C. Outside North America

Follow the procedure in Paragraph A or B immediately above but do not return product or part. You will be contacted regarding your claim.



Automatic Positive Locking Traction Differential

OWNER'S MANUAL Warnings & Precautions

Mechanic:

Any increase in the size of the vehicle's engine, tires, weight, etc., may prohibit use of a NoSPIN/Detroit Locker differential in a heretofore approved application. Any such modifications should be reviewed by Tractech Engineering before continuing to use the product.

Do not use heat to disassemble drive axles. To do so can destroy heat treat properties and weaken or distort axle components.

Turn the engine off and raise all driving wheels of a NoSPIN/Detroit Locker differential equipped axle when servicing wheels, brakes, axles or tires to prevent the vehicle from moving. Axles equipped with NoSPIN/Detroit Locker differentials deliver power to both wheels - even when only one wheel is on the ground.

NoSPIN/Detroit Locker differentials have compressed springs. Use a retaining bolt or some other restraining means when separating the differential case halves. (See pages 13-14) Do not lift the heavier (75 lbs. or over) units by the retaining bolt, as the washers may collapse or the threads may strip.

When repairing NoSPIN/Detroit Locker differentials, if major components show excessive wear, the complete differential should be replaced. If a component is replaced, mating components should also be replaced in that it is likely that they too are damaged. Use of worn or damaged components can lead to a recurrence of the original problem. (See page 15) Note: Use only Tractech approved components when repairing NoSPIN/Detroit Locker differentials.

Operator:

All NoSPIN/Detroit Locker differential equipped vehicles must be identified by a Caution Label. mounted on the instrument panel. Contact Tractech if this label was not received.

Do not operate the vehicle if both wheels of a NoSPIN/Detroit Locker differential equipped axle are not driving. Power to only one wheel can cause serious steering problems. Perform the installation and operation tests illustrated on page 12 before putting the vehicle into service.

Use extreme caution when accelerating or decelerating on slippery or unstable surfaces. Vehicles/axles equipped with traction differentials are inherently more sensitive to side-slip.

Distribute the load evenly side-to-side; do not exceed the vehicle's rated payload capacity; keep the diameter of the tires equal. Failure to observe these measures can create a difference in individual wheel speeds which can cause the NoSPIN/Detroit Locker differential to deliver power to only one side of the vehicle and thus cause steering problems.

Turn the engine off and raise all driving wheels of a NoSPIN/Detroit Locker differential equipped axle when changing tires to prevent the vehicle from moving. Axles equipped with NoSPIN/Detroit Locker differentials deliver power to both wheels - even when only one wheel is on the ground.

Operate in low gear when coasting downhill into a turn. Braking capacity is reduced when a NoSPIN/Detroit Locker differential equipped vehicle makes a turn while coasting downhill.

IMPORTANT! RE-READ THE WARNING NOTICES REFERENCED ABOVE. IN ADDITION TO THE CONSEQUENCES NOTED FAILURE TO OBSERVE ANY OR ALL OF THESE MEASURES, CAN CAUSE PART FAILURE OR RESULT IN A MISHAP WHICH CAN CAUSE PROPERTY DAMAGE, PERSONAL INJURY, EVEN DEATH

Axle Manufacture

Attach this envelope axle assemblies equipped with NoSPIN/Detroit Locker differentials.

Chassis Assembly Plant

Attach the enclosed Caution label to the instrument panel of NoSPIN/Detroit Locker differential equipped vehicles in plain view of operator or mechanic Place this manual in glove compartment of the vehicle.



11445 Stephens Drive P.O. Box 882
Warren, Michigan 48090 U.S.A.
PHONE - 586-759-3850 FAX - 586-759-1645